

GRUPO
DOBRE EIXO[®]
PEÇAS PARA BAÚS E SIDER
+5511 2087-5322



Lealdade em Negócios



BAÚ PARTS

PEÇAS PARA BAÚS E SIDER

(19) 3864-0522

WWW.BAUPARTS.COM.BR



DOBRE EIXO

PEÇAS PARA BAÚS E SIDER

FRISAMOS TODOS OS MODELOS DE CHAPAS PARA FURGÕES DURA ALUMÍNIO QUE RODA NO BRASIL E AMÉRICA LATINA COM MAQUINAS MODERNAS PARA QUE SEU EQUIPAMENTO FIQUE SEMPRE ORIGINAL.

FRISAMOS CHAPAS PARA FABRICANTES DE FURGÕES

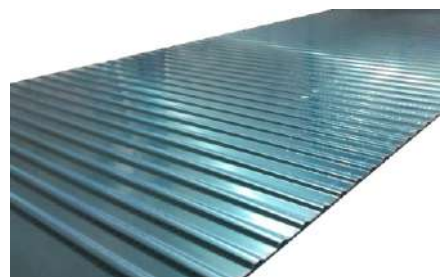

ÍNDICE

ANTONINI	PÁG. 6
CARGO VAN / GALEGO / BERTOLINI	PÁG. 10
CARBUS	PÁG. 14
EDARP	PÁG. 18
FACCHINI	PÁG. 21
FURCAR	PÁG. 28
GUERRA	PÁG. 31
IDEROL / ROSSETTI	PÁG. 34
MAXFORT	PÁG. 38
METALCAR	PÁG. 41
NOMA	PÁG. 44
RANDON	PÁG. 48
RODA DE OURO	PÁG. 52
RODOFORT	PÁG. 55
SÃO PEDRO	PÁG. 59
TRUCKVAN	PÁG. 61
QUADRO LATERAL E QUADRO TRASEIRO	PÁG. 64
PORTA CONVENCIONAL	PÁG. 67
SIDER	PÁG. 69
PEÇAS PARA BASES	PÁG. 78
CARROCERIA CARGA SECA	PÁG. 80
MULTIMARCAS	PÁG. 83
CARROCERIA DE BEBIDAS FACCHINI E RODOFORT	PÁG. 99
CARROCERIA DE BEBIDAS RANDON	PÁG. 103
PORTA ROLL-UP 100%ALUMINIO	PÁG. 108
PORTA ROLL-UP DE MADEIRA REVESTIDA COM ALUMINIO	PÁG. 112
PEÇAS PARA PORTA ROLL-UP MULTIMARCAS	PÁG. 116
PORTA ROLL-UP REFRIGERADA	PÁG. 117
PORTAS ROLL-UP PARA DOCAS	PÁG. 121



DOBRE EIXO[®]
PEÇAS PARA BAÚS E SIDER

Lealdade em Negócios

QUEM SOMOS

Somos Fornecedores de peças para Implementos Rodoviários Inauguramos no final de 2012 Porém com uma visão muito madura a respeito do mercado.

Além de uma Infinitude de peças para baús Sider e carroceria de bebida. Trabalhamos com corte e dobra de aço e toda linha de chapas para Baús.

NOSSA MISSÃO

Nossa missão é atender nossos clientes Buscando oferecer nossos produtos, pontualidade na entrega preço e respeito

WWW.DOBREEIXO.COM.BR

(11) 2087 - 5322



DOBRE EIXO[®]

PEÇAS PARA BAÚS E SIDER

Lealdade em Negócios

PEÇAS PARA BAÚS

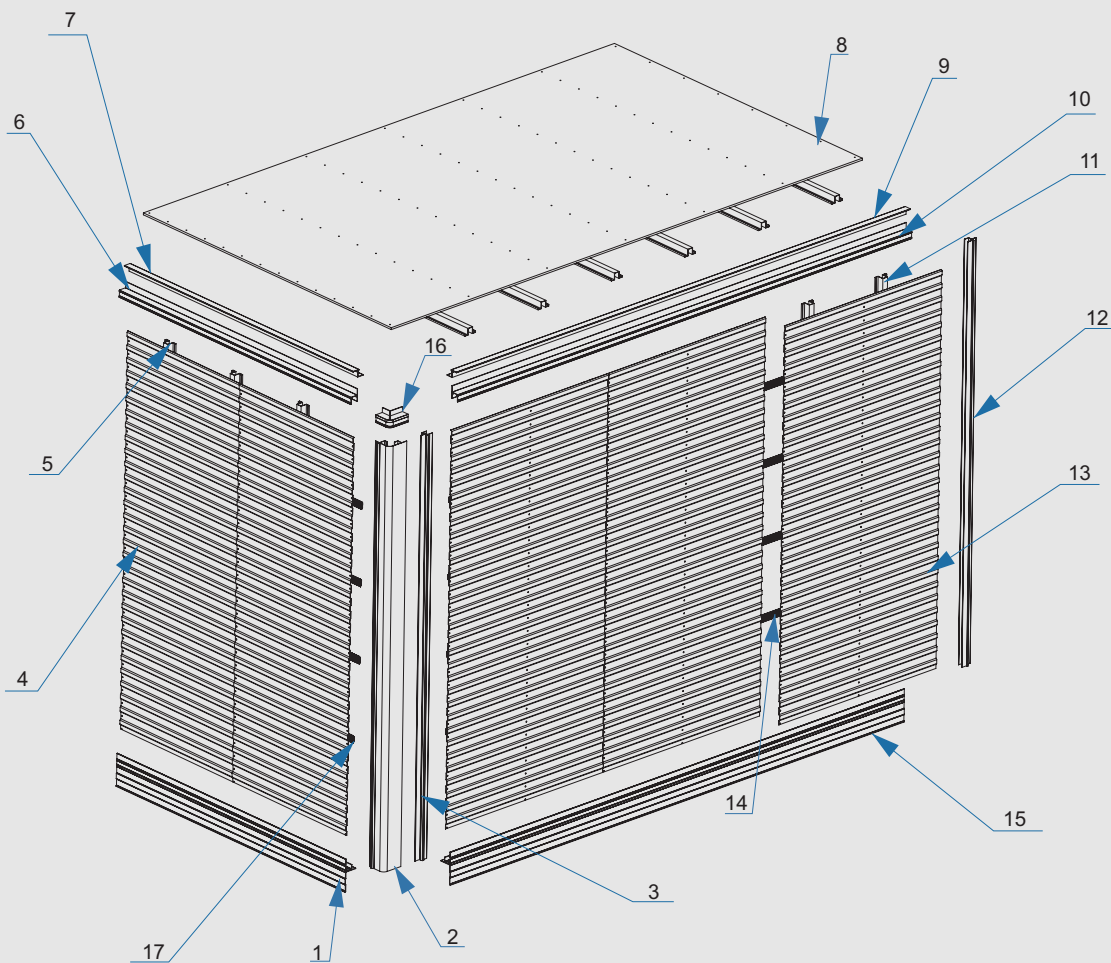

WWW.DOBREEIXO.COM.BR

- 1 - Saia Frontal
- 2 - Coluna
- 3 - Fechamento da Coluna
- 4 - Chapa Frisada ou Lisa
- 5 - Cartola Frontal
- 6 - Longarina Frontal
- 7 - Contorno do Teto Frontal
- 8 - Chapa do Teto
- 9 - Contorno do Teto Lateral

- 10 - Longarina do Teto Lateral
- 11 - Cartola Lateral
- 12 - Fechamento
- 13 - Chapa Lisa ou Frisada
- 14 - Ripa Galvanizada Lateral
- 15 - Saia Lateral
- 16 - Canto Superior
- 17 - Ripa Galvanizada Frontal

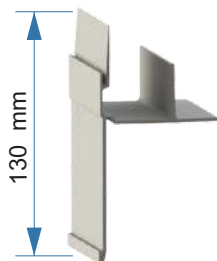

Saia 130
50.01.001

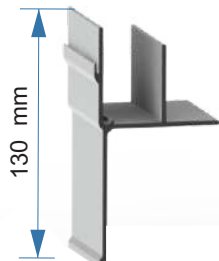

Saia 130
50.01.002

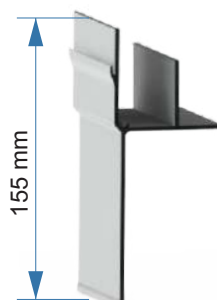

Saia Nova 155
50.01.004

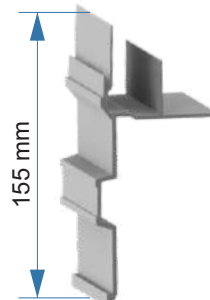

Saia Antiga 155
50.01.003

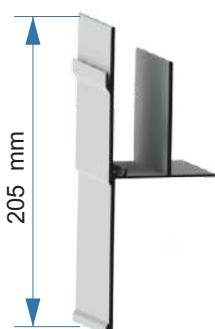

Saia 205 mm
50.01.005

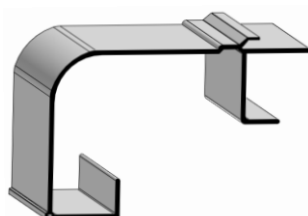

Coluna frontal
50.01.020



Fechamento Frontal
50.01.025



Cartola AG
99.00.061



Cartola de Alumínio
99.00.162



Contorno de Teto
50.01.015



Longarina Superior
50.01.010



Perfil Z
50.02.045



Perfil Z
99.00.382



Perfil Virgula
50.02.050



Perfil J
50.07.050



Contorno de Porta
99.00.639



Canto Antonini Inferior
D - 99.00.065
E - 99.00.066



Canto Antonini Superior
99.00.579

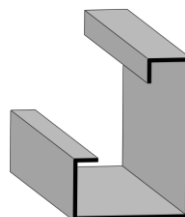

Coluna do Quadro Tras.
99.00.635

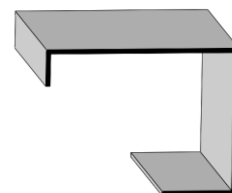

Travessa Inferior
99.00.636

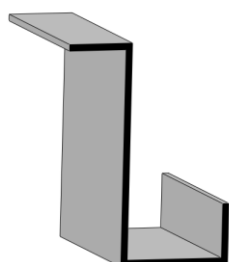

Travessa Superior
99.00.637

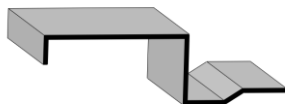

Perfil Calha
99.00.735

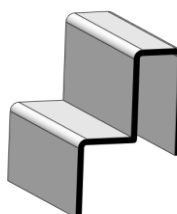

Trav. Inf. do Q. Lat. Estreito
99.00.028

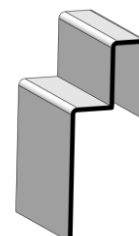

Trav. Inf. do Q. Lat. largo
99.00.613

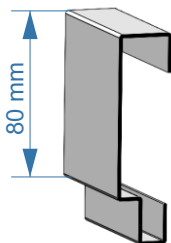

Coluna do Q. Lateral
99.00.026

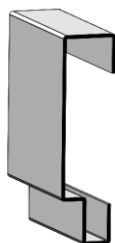

Travessa Sup. do Q. Lat.
99.00.029

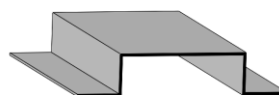

Cartola de Porta A.G
100 mm - 20.00.007
140 mm - 99.00.549



Borracha
99.00.346



Caixa do Came
D.11.00.003
E.11.00.004



Cavalete Traseiro
99.00.183



Cavalete Lateral
99.00.279



Came
D - 11.00.001
E - 11.00.002



Lingueta F.F
D - 11.00.005
E - 11.00.006



Castanha Curt. e Long.
C - 11.00.008
L - 11.00.007



Sup. da Alav. GRD. e PEQ.
G - 10.00.002
P - 10.00.007



Alavanca GRD. e PEQ.
G - 10.00.001
P - 10.00.006



Pino da Alavanca
1/2 - 10.00.003
3/8 - 10.00.008



Trava Alav. GRD. e PEQ.
G - 10.00.004
P - 10.00.009



Tramela GRD. e PEQ.
G - 10.00.005
P - 10.00.010



Base do Mancal
3/4 - 10.00.012
1" - 10.00.014



Mancal
3/4 - 10.00.011
1" - 10.00.013



Guia do Came
10.00.025



Bandeja de Alumínio
G - 99.00.099
P - 10.00.026

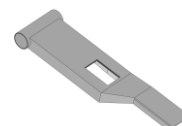

Manete Menor AG
10.00.028



Manete Maior AG
99.00.098





Bico de Papagaio
10.00.030











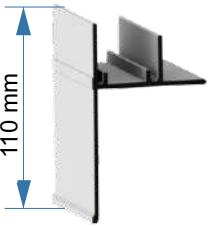
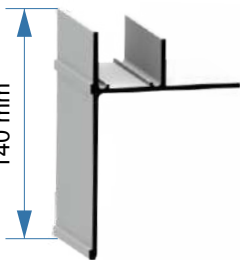
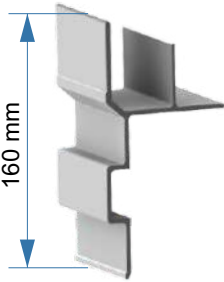









Pino da Dobradiça
90 mm - 10.00.019
95 mm - 10.00.020

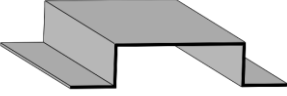
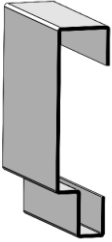
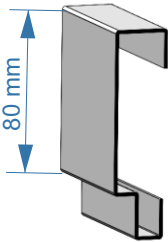
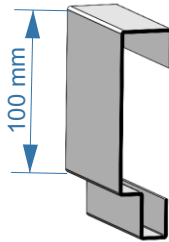
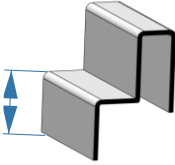
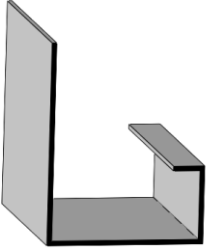
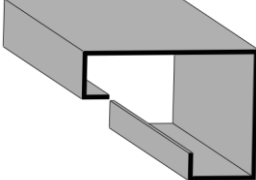
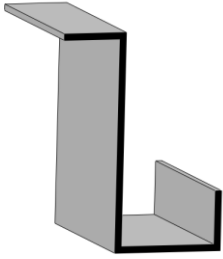
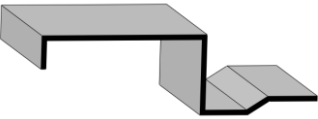

Varão
25 mm - 99.00.015
32 mm - 99.00.006

 <p>Trava Porta Femea 10.00.018</p>	 <p>Trava Porta Macho 10.00.017</p>	 <p>Dobradiça Tras. 10.02.001</p>	 <p>Dobradiça Lateral 10.02.003</p>
 <p>Contra Pino 1/8X1" - 99.00.257 3/16X2" - 13.00.003 1/8X1.1/2 - 99.00.256 1/8 2 1/2 - 99.00.745</p>	 <p>Pino Elastico 5x26 cod. 99.00.219 5X32 cod. 99.00.254 6x26 cod. 99.00.171 6x32 cod. 99.00.255</p>	 <p>Anel de Encosto 1" - 10.00.016 3/4 - 10.00.015</p>	 <p>Plug de Plastico 99.00.001</p>
 <p>Batente de Porta Galv. Cod - 99.00.374 Alumi. Cod - 50.02.035</p>	 <p>Chapa Lisa Branca 99.00.003</p>	 <p>Chapa Lisa 99.00.010</p>	 <p>Chapa Frisada 99.20.001</p>
 <p>Chapa de alum. Inteiriça 10.20.003</p>	<p>Aceitamos todos os cartões</p> 	<p>Aceitamos todos os cartões</p> 	<p>Aceitamos cartão</p> 

 <p>Saia 110 50.02.001</p>	 <p>Saia 140 50.02.002</p>	 <p>Saia 160 50.03.002</p>	 <p>Coluna Frontal 50.02.020</p>
 <p>Fechamento 50.02.025</p>	 <p>Cartola AG 99.00.061</p>	 <p>Contorno do Teto 50.02.015</p>	 <p>Longarina 50.02.010</p>
 <p>Perfil Z 50.02.045</p>	 <p>Perfil Vír gula 50.02.050</p>	 <p>Perfil J 50.07.050</p>	 <p>Contorno de Porta 50.02.030</p>
 <p>Canto Cargo Van Inferior D - 99.00.117 E - 99.00.175</p>	 <p>Canto Cargo van Inf. D - 99.00.106 E - 99.00.107</p>	 <p>Canto Cargo Van Traseiro D - 99.00.736 E - 99.00.100</p>	 <p>Canto CV Alumi. ou Nylon Alumi. - D - 99.00.737 Alumi. - E - 99.00.738 Nylon. - D - 99.00.312 Nylon. - E - 99.00.313</p>

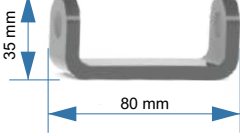
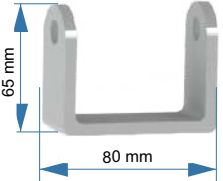
 <p>Cartola de Porta AG 100 mm - 20.00.007 140 mm - 99.00.549</p>	 <p>Travessa Superior 99.00.029</p>	 <p>Coluna Q. Lat. 80 mm 99.00.026</p>	 <p>Coluna Q. Lat. 100 mm 99.00.027</p>
 <p>Travessa Inferior Aba Curta - 99.00.028 Aba Longa - 99.00.613</p>	 <p>Coluna Traseira 99.00.038</p>	 <p>Travessa Inferior 99.00.611</p>	 <p>Trave. Sup. do Qua. Tras. 99.00.193</p>
 <p>Perfil Calha 99.00.192</p>	 <p>Came D - 11.00.001 E - 11.00.002</p>	 <p>Caixa do Came D - 11.00.003 E - 11.00.004</p>	 <p>Lingueta F.F D - 11.00.005 E - 11.00.006</p>
 <p>Cavalete Inclinado 10.02.011</p>	 <p>Cavalete Reto 10.02.010</p>	 <p>Cavalete Lateral 10.02.012</p>	 <p>Cavalete 99.00.275</p>



Castanha Curt. e Long.
C - 11.00.008
L - 11.00.007

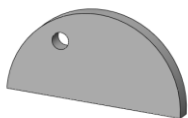

Sup. da alava. Meia Lua
99.00.463



Alavanca de Alumínio
99.00.039



Trava da Alavança
99.00.129



Tramela Alumínio
99.00.118



Base do Mancal
3/4 - 10.00.012
1" - 10.00.014



Mancal
3/4 - 10.00.011
1" - 10.00.013



Guia do Came
10.00.025



Bandeja de Alumínio
G - 99.00.099
P - 10.00.026



Bandeja com Gatilho
99.00.191



Gatilho Mapinha
99.00.486

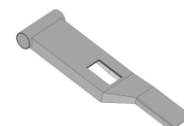

Manete Menor AG
10.00.028



Manete Maior AG
99.00.098



Manete
99.00.271



Bico de Papagaio
10.00.030



Pino da Dobradiça
90 mm - 10.00.019
95 mm - 10.00.020

 <p>Varão 25 mm - 99.00.015 32 mm - 99.00.006</p>	 <p>Trava Porta Femea 10.00.018</p>	 <p>Trava Porta Macho 10.00.017</p>	 <p>Dobradiça Tras. 10.02.001</p>
 <p>Dobradiça Lateral 10.02.003</p>	 <p>Contra Pino 1/8X1" - 99.00.257 3/16X2" - 13.00.003 1/8X1.1/2 - 99.00.256 1/8 2 1/2 - 99.00.745</p>	 <p>Pino Elastico 5x26 cod. 99.00.219 5x32 cod. 99.00.254 6x26 cod. 99.00.171 6x32 cod. 99.00.255</p>	 <p>Anel de Encosto 1" - 10.00.016 3/4 - 10.00.015</p>
 <p>Plug de Plastico 99.00.001</p>	 <p>Cartola Galv. Curvada 99.00.111</p>	 <p>Borracha CV 99.00.007</p>	 <p>Borracha CV Com Aba 99.00.649</p>
 <p>Batente de Porta Galv. Cod - 99.00.374 Alumi. Cod - 50.02.035</p>	 <p>Entrada de AR CV 99.00.896</p>	 <p>Chapa Lisa 99.00.010</p>	 <p>Chapa Frisada 99.20.001</p>

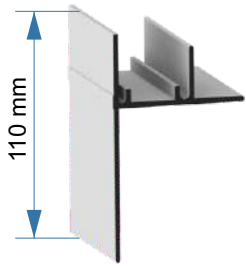

Saia 110
50.03.001

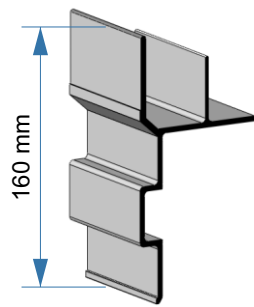

Saia 160 Antiga
50.03.002

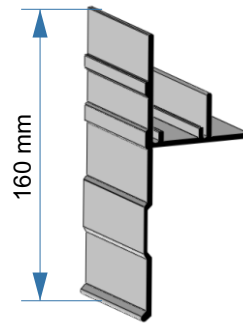

Saia 160
50.03.003



Coluna Leve
50.03.020

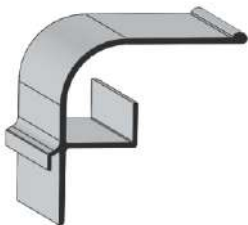

Coluna Leve Nova
50.03.022

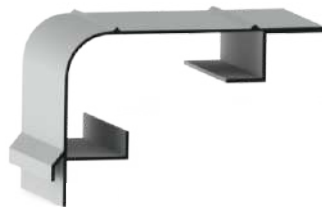

Coluna Pesada
50.03.021



Fechamento
50.02.025



Cartola AG
99.00.061



Contorno de Teto
50.02.015



Longarina
50.00.369



Perfil Z
50.02.045



Perfil Vígula
50.02.050



Perfil J
50.07.050



Canto Superior Leve de
Nylon ou Alum.

Nylon - D - 99.00.315

Nylon - E - 99.00.316

Alumi. - D - 99.00.044

Alumi. - E - 99.00.045



Canto CB Superior Pesado
de Nylon ou Alum.

Nylon - D - 99.00.312

Nylon - E - 99.00.313

Alumi. - D - 99.00.737

Alumi. - E - 99.00.738



Canto CV Inferior

D - 99.00.117

E - 99.00.175

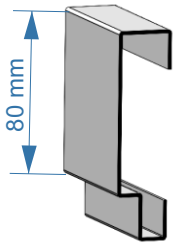

Coluna Q. Lat. 80 mm
99.00.026

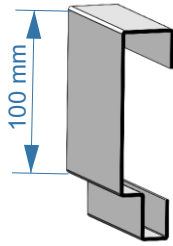

Coluna Q. Lat. 100 mm
99.00.027

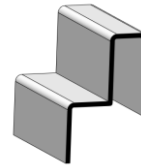

Travessa Inferior
99.00.028

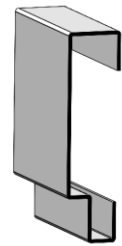

Travessa Sup. Quadro Lat
99.00.029

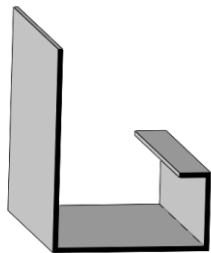

Coluna Traseira
99.00.038

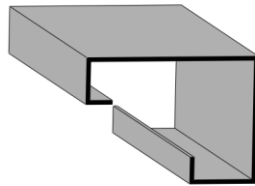

Travessa Inf. do Quad. Tras.
99.00.611

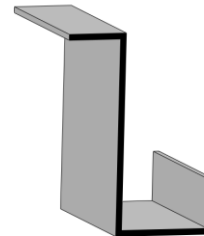

Traves. Sup. do Quad. Tras.
99.00.193

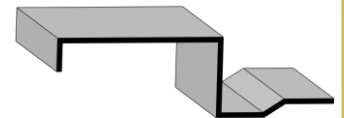

Calha
99.00.192



Borracha CV
99.00.007

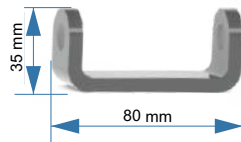

Cavalete Lateral
10.02.012

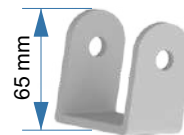

Cavalete Inclinado
10.02.011

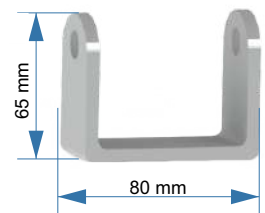

Cavalete Reto
10.02.010



Came
D.11.00.001
E.11.00.002



Lingueta F.F
D - 11.00.005
E - 11.00.006



Castanha Curt. e Long.
C - 11.00.008
L - 11.00.007



Suporte da Alavanca
99.00.463

 <p>Alavanca Alumínio 99.00.039</p>	 <p>Trava da Alavanca 99.00.129</p>	 <p>Tramela Alumínio 99.00.118</p>	 <p>Base do Mancal 3/4 - 10.00.012 1" - 10.00.014</p>
 <p>Mancal 3/4 - 10.00.011 1" - 10.00.013</p>	 <p>Guia do Came 10.00.025</p>	 <p>Bandeja de Alumínio G - 99.00.099 P - 10.00.026</p>	 <p>Bandeja com Gatilho 99.00.191</p>
 <p>Gatilho Mapinha 99.00.486</p>	 <p>Manete Menor AG 10.00.028</p>	 <p>Manete Maior AG 99.00.098</p>	 <p>Manete 99.00.271</p>
 <p>Bico de Papagaio 10.00.030</p>	 <p>Pino da Dobradiça 90 mm - 10.00.019 95 mm - 10.00.020</p>	 <p>Varão 25 mm - 99.00.015 32 mm - 99.00.006</p>	 <p>Trava Porta Femea 10.00.018</p>

 <p>Trava Porta Macho 10.00.017</p>	 <p>Dobradiça Traseira 10.03.001</p>	 <p>Dobradiça Lateral 10.03.002</p>	 <p>Contra Pino 1/8X1" - 99.00.257 3/16X2" - 13.00.003 1/8X1.1/2 - 99.00.256 1/8 2 1/2 - 99.00.745</p>
 <p>Pino Elastico 5x32 cod. 99.00.254 5x26 cod. 99.00.219 6x26 cod. 99.00.171 6x32 cod. 99.00.255</p>	 <p>Anel de Encosto 1" - 10.00.016 3/4 - 10.00.015</p>	 <p>Plug de Plastico 99.00.001</p>	 <p>Cartola de Porta 100 mm - 20.00.007 140 mm - 99.00.549</p>
 <p>Cartola Galv. Curvada 99.00.111</p>	 <p>Batente de Porta Galv. Cod - 99.00.374 Alumi. Cod - 50.02.035</p>	 <p>Entrada de ar CB 12.03.001</p>	 <p>Chapa Lisa 99.00.010</p>
 <p>Chapa de Alum. Inteiriça 10.20.003</p>	 <p>Chapa Frisada 99.20.001</p>	 <p>Chapa Lisa Branca 99.00.003</p>	<p>Aceitamos todos os cartões</p>  

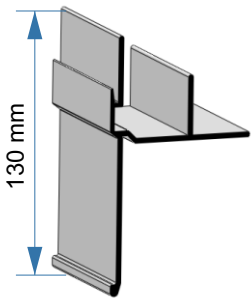

Saia 130
50.01.001

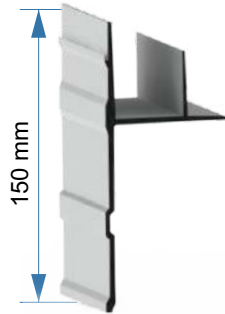

Saia 150
50.05.003



Coluna ED 80 x 100
99.00.441



Coluna ED 100 x 110
99.00.053



Coluna ED P/ 2 Fechamentos
99.00.606



Fechamento ED Novo
99.00.607



Fechamento ED
99.00.057



Contorno do Teto
99.00.221



Longarina
99.00.223



Perfil Z
50.02.045



Perfil Vígula
50.02.050



Canto Edarp
99.00.310



Came
D - 11.00.001
E - 11.00.002



















Lingueta F.F
D - 11.00.005
E - 11.00.006

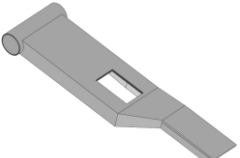

Castanha Curt. e Long.
C - 11.00.008
L - 11.00.007



Sup. da Alav. GRD. e PEQ.
G - 10.00.002
P - 10.00.007

 <p>Alavanca GRD. e PEQ. G - 10.00.001 P - 10.00.006</p>	 <p>Pino da Alavanca 3/8 - 10.00.008 1/2 - 10.00.003</p>	 <p>Trava Alavanca GRD. e PEQ. G - 10.00.004 P - 10.00.009</p>	 <p>Tramela GRD. e PEQ. G - 10.00.005 P - 10.00.010</p>
 <p>Base do Mancal 3/4 - 10.00.012 1" - 10.00.014</p>	 <p>Mancal 3/4 - 10.00.011 1" - 10.00.013</p>	 <p>Guia do Came 10.00.025</p>	 <p>Bandeja de Alumínio G - 99.00.099 P - 10.00.026</p>
 <p>Manete Menor AG 10.00.028</p>	 <p>Manete Maior AG 99.00.098</p>	 <p>Bico de Papagaio 10.00.030</p>	 <p>Pino da Dobradiça 90 mm - 10.00.019 95 mm - 10.00.020</p>
 <p>Varão 25 mm - 99.00.015 32 mm - 99.00.016</p>	 <p>Trava Porta Femea 10.00.018</p>	 <p>Trava Porta Macho 10.00.017</p>	 <p>Dobradiça Traseira 10.03.001</p> <p>260 mm 60 mm</p>

 <p>Dobradiça Lateral 10.03.002</p>	 <p>Contra Pino 1/8X1" - 99.00.257 3/16X2" - 13.00.003 1/8X1.1/2 - 99.00.256 1/8 2 1/2 - 99.00.745</p>	 <p>Pino Elastico 5x26 cod. 99.00.219 5X32 cod. 99.00.254 6x26 cod. 99.00.171 6x32 cod. 99.00.255</p>	 <p>Anel de Encosto 1" - 10.00.016 3/4 - 10.00.015</p>
 <p>Plug de Plastico 99.00.001</p>	 <p>Cartola de Porta 100 mm - 20.00.007 140 mm - 99.00.549</p>	 <p>Cartola AG 99.00.061</p>	 <p>Cartola Curvada 99.00.111</p>
 <p>Cavalete Reto 10.02.010</p>	 <p>Cavalete Lateral 10.02.012</p>	 <p>Borracha ED 99.00.740</p>	 <p>Borracha ID 99.00.033</p>
 <p>Batente de Porta Galv. Cod - 99.00.374 Alumi. Cod - 50.02.035</p>	 <p>Chapa Frisada 99.20.001</p>	 <p>Chapa Lisa Branca 99.00.003</p>	<p>Aceitamos cartão</p> 

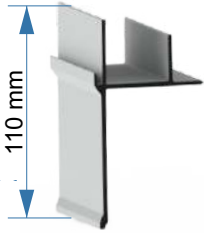

Saia 110
50.04.001

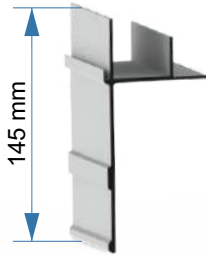

Saia 145
50.04.002

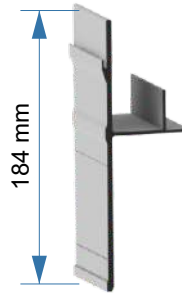

Saia 184
50.04.003

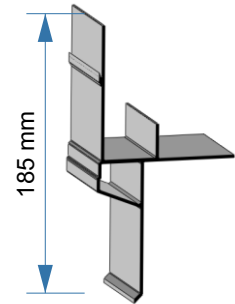

Saia 185 Tubular
50.04.004



Coluna
50.04.020



Coluna larga
50.04.021



Coluna Frigorifica
99.00.176

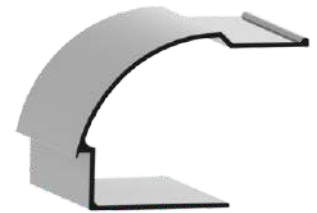

Coluna Frigorifica
99.00.575



Coluna Larga s/ Aba
50.04.022

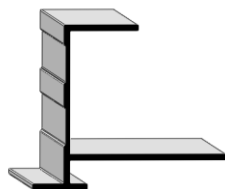

Fechamento Novo
50.04.026



Fechamento Antigo
50.04.025



Cartola AG e Alum.
AG. - 99.00.061
Alumi. - 99.00.162



Longarina Sup. 65 mm
50.04.011

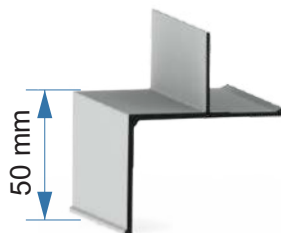

Longarina Superior 50 mm
50.04.010



Longarina Superior
50.04.012

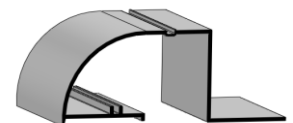

Contorno de Teto Redondo
50.04.016

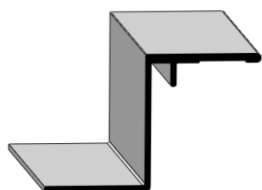

Contorno de Teto
50.04.015



Perfil Z
50.07.045



Perfil Virgula
50.02.050



Perfil J
50.07.050



Arremate de Teto
50.04.050

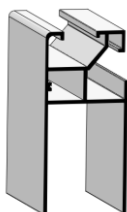

Contorno de Porta
50.04.031



Contorno de Porta 40 mm
99.00.182



Contorno de Porta 50 mm
50.04.030

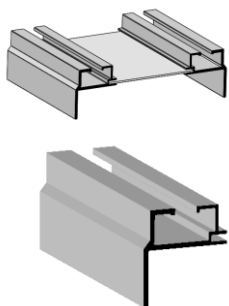

Contorno de Porta
CJ - 12.04.001
Peça - 99.00.472



Contorno de Porta
99.00.473



Contorno de Porta
50.04.032



Canto FC Sup. Frontal
99.00.021



Canto FC Sup. Frontal
D - 99.00.213
E - 99.00.075



Canto Facchini
99.00.014



Canto Facchini inf. Frontal
99.00.456



Canto Facchini
Plas. - 99.00.018
Alum. - 99.00.591

 <p>Canto de Ref. da coluna FC Sup: 99.00.813 Inf: 99.00.812</p>	 <p>Coluna Lateral 99.00.625</p>	 <p>Travessa Inferior 99.01.555</p>	 <p>Calha 99.00.322</p>
 <p>Travessa Superior 99.00.621</p>	 <p>Coluna Traseira 99.00.232</p>	 <p>Travessa Inferior 99.00.554</p>	 <p>Coluna Traseira 120 x 60 mm Cod: 99.00.378 100 x 60 mm Cod: 99.00.638 80 x 60 mm Cod: 99.00.321</p>
 <p>Cartola de Porta FC 125 mm - 20.00.009 160 mm - 99.00.855</p>	 <p>Borracha FC 99.00.083</p>	 <p>Borracha FC 99.00.004</p>	 <p>Borracha Batente 99.00.147</p>
 <p>Borracha FC porta Injetada 99.00.113</p>	 <p>Borracha FC Porta Inj. Nova 15.04.008</p>	 <p>Caixa do Came D - 11.00.003 E - 11.00.004</p>	 <p>Cavalete Plas. Tras. D - 99.00.516 E - 99.00.517</p>



Cavalete de Lat. Plas.
D - 99.00.250
E - 99.00.251

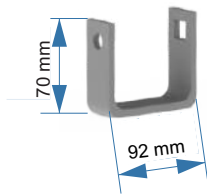

Cavalete Tras.
10.04.011

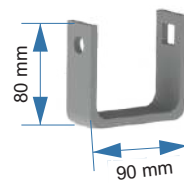

Cavalete Tras.
10.04.010

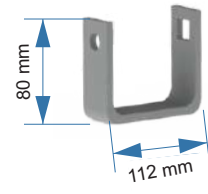

Cavalete largo Tras. Ant.
99.00.172

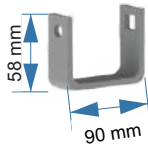

Cavalete Lat.
10.04.012



Came
D - 11.00.001
E - 11.00.002



Lingueta Serie Pesado
D - 99.00.094
E - 99.00.097



Lingueta Serie Leve
D - 99.00.185
E - 99.00.186

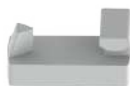

Engate da Lingueta
G - 99.00.101
P - 99.00.102



Trava Alavanca FC
99.00.444

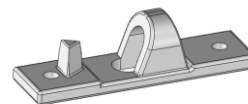

Engate FC 2007
99.00.623



Lingueta
99.00.227

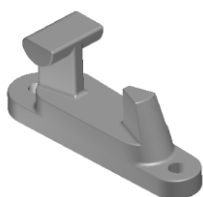

Engate da lingueta
FC C/ Parafuso
99.00.794

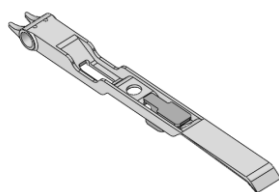

Alavanca FC
11.00.010

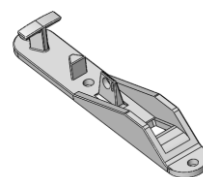

Base da Alavanca FC
11.00.009



Sup. da Alav. GRD. e PEQ
G - 10.00.002
P - 10.00.007

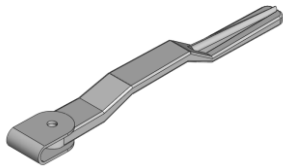

Alavanca FF
99.00.179



Base e Mancal
PEQ - 99.00.060
GRD - 99.00.002



Mancal de Plas.
99.00.589

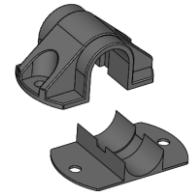

Mancal e Base FC de
Plástico GRD
99.00.887

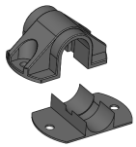

Mancal e Base FC de
Plástico PEQ.
99.00.901



Trinco FC de Plástico
99.00.340



Bandeja FC S/ Prisioneiros
17.04.006



Bandeja FC C/ Prisioneiros
99.00.332

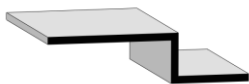

Batente de Porta
Galv. Cod - 99.00.374
Alumi. Cod - 50.02.035



Trava Porta Macho
10.00.017



Trava Porta Femea
10.00.018

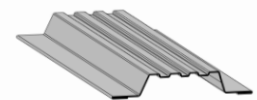

Ripa Galvanizada
20.00.011



Trava Porta Mac. e Fem.
Macho - 99.00.287
Femea - 99.00.278



Dobradiça FC
10.04.003

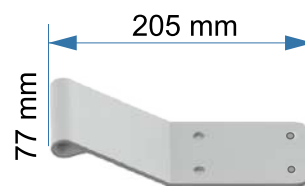

Dobradiça FC Traseira
10.04.002

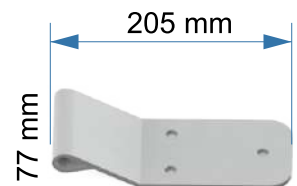

Dobradiça FC Traseira
10.04.001

 <p>Dobradiça FC Lat. de Alum. 99.00.136</p>	 <p>Dobradiça FC Tras. de Alum. 99.00.443</p>	 <p>Dobradiça de plast. FC 99.00.339</p>	 <p>Dobradiça FC 99.00.467</p>
 <p>Dobradiça FC Frigorifica 50.04.034</p>	 <p>Dobradiça FC 99.00.521</p>	 <p>Dobradiça Olhal FC 99.00.165</p>	 <p>Cavalete da dobra. olhal 99.00.293</p>
 <p>Suporte da dobra. olhal 99.00.253</p>	 <p>Pino da Dobradiça olhal 99.00.294</p>	 <p>Tubo Oblongo 99.00.163</p>	 <p>Contra Pino 1/8X1" - 99.00.257 3/16X2" - 13.00.003 1/8X1.1/2 - 99.00.256 1/8 2 1/2 - 99.00.745</p>
 <p>Abraçadeira 99.00.164</p>	 <p>Entrada de Ar FC 99.00.363</p>	 <p>Pino da Dobradiça 100 mm 99.00.173</p>	 <p>Pino da Dobradiça 115 mm 10.00.023</p>



Paraf. SX 1/4 X 2. 1/2 C/ Rosca
99.00.531



Guia do Came FC
99.00.831

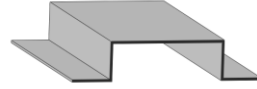

Cartola Dupla FC Gav.
99.00.344

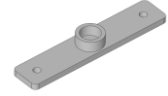

Guia do Came Porta Injetada
99.00.333



Bucha da Dobradiça
99.00.252



Batente de Borracha FC
15.00.012



Batente de Borracha FC
15.00.009



Chapa do Teto Interiça
10.20.003



Chapa Lisa Branca
99.00.003



Chapa Lisa
99.00.010

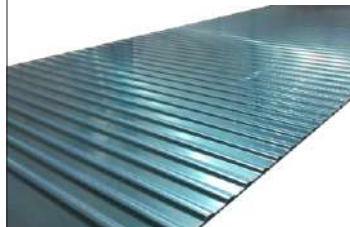

Chapa Frisada
99.20.001

Aceitamos Todos os Cartões



Aceitamos cartão



Aceitamos Todos os Cartões















Aceitamos cartão

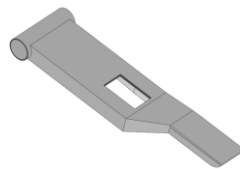





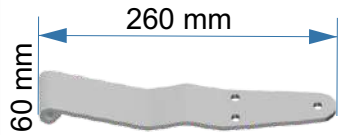
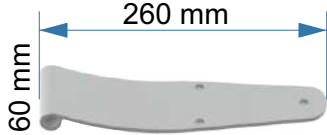



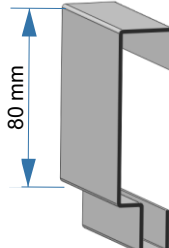
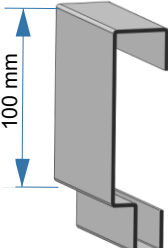
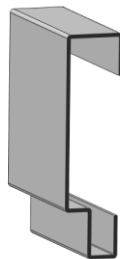
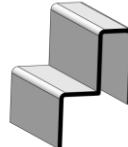

Aceitamos Todos os Cartões

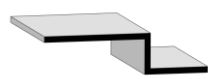

 <p>Saia 133 99.00.184</p>	 <p>Saia 160 99.00.676</p>	 <p>Coluna Frontal 99.00.360</p>	 <p>Fechamento 99.00.361</p>
 <p>Contorno de Teto 50.01.015</p>	 <p>Longarina Superior 50.01.010</p>	 <p>Perfil Z 50.02.045</p>	 <p>Perfil Virgula 50.02.050</p>
 <p>Contorno de Porta 50.02.030</p>	 <p>Canto Superior Furcar 99.00.579</p>	 <p>Came D - 11.00.001 E - 11.00.002</p>	 <p>Lingueta F.F D - 11.00.005 E - 11.00.006</p>
 <p>Castanha Curt. e Long. C - 11.00.008 L - 11.00.007</p>	 <p>Sup. da Alav. GRD. e PEQ. G - 10.00.002 P - 10.00.007</p>	 <p>Alavanca GRD. e PEQ. G - 10.00.001 P - 10.00.006</p>	 <p>Pino da Alavanca 1/2 - 10.00.003 3/8 - 10.00.008</p>

 <p>Trava Alav. GRD. e PEQ. G - 10.00.004 P - 10.00.009</p>	 <p>Tramela GRD. e PEQ. G - 10.00.005 P - 10.00.010</p>	 <p>Base do Mancal 3/4 - 10.00.012 1" - 10.00.014</p>	 <p>Mancal 3/4 - 10.00.011 1" - 10.00.013</p>
 <p>Guia do Came 10.00.025</p>	 <p>Bandeja de Alumínio G - 99.00.099 P - 10.00.026</p>	 <p>Manete Menor AG 10.00.028</p>	 <p>Manete Maior AG 99.00.098</p>
 <p>Bico de Papagaio 10.00.030</p>	 <p>Pino da Dobradiça 95 mm - 10.00.020 90 mm - 10.00.019</p>	 <p>Varão 32 mm - 99.00.006 25 mm - 99.00.015</p>	 <p>Trava Porta Femea 10.00.018</p>
 <p>Trava Porta Macho 10.00.017</p>	 <p>260 mm 60 mm</p> <p>Dobradiça Traseira 10.03.001</p>	 <p>260 mm 60 mm</p> <p>Dobradiça Lateral 10.03.002</p>	 <p>Contra Pino 1/8X1" - 99.00.257 3/16X2" - 13.00.003 1/8X1.1/2 - 99.00.256 1/8 2 1/2 - 99.00.745</p>

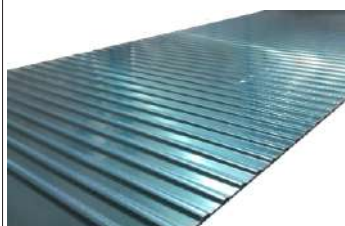
 <p>Pino Elastico 5x26 cod. 99.00.219 5x32 cod. 99.00.254 6x26 cod. 99.00.171 6x32 cod. 99.00.255</p>	 <p>Anel de encosto 1" - 10.00.016 3/4 - 10.00.015</p>	 <p>Plug de Plastico 99.00.001</p>	 <p>Coluna Q. Lat. 80 mm 99.00.026</p>
 <p>Coluna Q. Lat. 100 mm 99.00.027</p>	 <p>Travessa Superior 99.00.029</p>	 <p>Travessa Inf. do Quad. Lat 99.00.613</p>	 <p>Cartola de Porta 100 mm - 20.00.007 140 mm - 99.00.549</p>
 <p>Cavalete Reto 10.02.010</p>	 <p>Cavalete Lateral 10.02.012</p>	 <p>Borracha CV 99.00.007</p>	 <p>Cartola AG 99.00.061</p>
 <p>Cartola Curvada 99.00.111</p>	 <p>Batente de Porta Galv. Cod - 99.00.374 Alumi. Cod - 50.02.035</p>	 <p>Chapa Lisa 99.00.010</p>	 <p>Chapa Frisada 99.20.001</p>

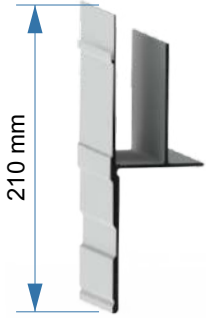

Saia 210
99.00.272



Coluna Frontal
99.00.169



Fechamento Antigo
50.04.025



Cartola
99.00.061

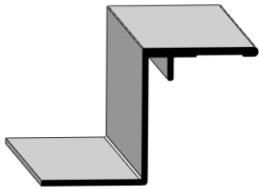

Contorno de Teto
50.04.015



Longarina
99.00.343



Perfil Vígula
50.02.050



Perfil J
50.07.050



Contorno de Porta
50.04.642



Canto Superior
99.00.174



Borracha GR
99.00.007



Borracha GR
99.00.379

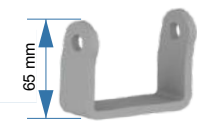

Cavalete Inclinado
99.00.629



Lingueta F.F
D - 11.00.005
E - 11.00.006



Castanha Curt. e Long.
C - 11.00.008
L - 11.00.007



Sup. da Alav. GRD e PEQ.
G - 10.00.002
P - 10.00.007

 <p>Alavanca GRD. e PEQ. G - 10.00.001 P - 10.00.006</p>	 <p>Pino da Alavanca 1/2 - 10.00.003 3/8 - 10.00.008</p>	 <p>Trava Alavanca GRD. e PEQ. G - 10.00.004 P - 10.00.009</p>	 <p>Tramela GRD. e PEQ. G - 10.00.005 P - 10.00.010</p>
 <p>Mancal 3/4 - 10.00.011 1" - 10.00.013</p>	 <p>Base do Mancal 3/4 - 10.00.012 1" - 10.00.014</p>	 <p>Guia do Came 10.00.025</p>	 <p>Bandeja de Alumínio G - 99.00.099 P - 10.00.026</p>
 <p>Manete Menor AG 10.00.028</p>	 <p>Manete Maior AG 99.00.098</p>	 <p>Bico de Papagaio 10.00.030</p>	 <p>Pino da Dobradiça 90 mm - 10.00.019 95 mm - 10.00.020</p>
 <p>Varão 25 mm - 99.00.015 32 mm - 99.00.006</p>	 <p>Trava Porta Femea 10.00.018</p>	 <p>Trava Porta Macho 10.00.017</p>	 <p>Dobradiça Tras. 99.00.590</p> <p>250 mm 75 mm</p>



Dobradiça Lateral
10.07.002



Engate da Lingüeta GR
21.00.030



Contra Pino
1/8X1" - 99.00.257
3/16X2" - 13.00.003
1/8X1.1/2 - 99.00.256
1/8 2 1/2 - 99.00.745



Anel de Encosto
1" - 10.00.016
3/4 - 10.00.015



Plug de Plastico
99.00.001



Pino Elastico
5x26 cod. 99.00.219
5x32 cod. 99.00.254
6x26 cod. 99.00.171
6x32 cod. 99.00.255

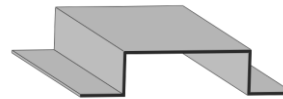

Cartola de Porta
100 mm - 20.00.007
140 mm - 99.00.549



Cartola Curvada
99.00.111

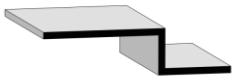

Batente de Porta
Galv. Cod - 99.00.374
Alumi. Cod - 50.02.035



Chapa Lisa
99.00.010



Chapa do Teto Interiça
10.20.003

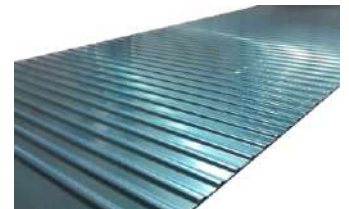

Chapa Frisada
99.20.001



Chapa Lisa Branca
99.00.003

Aceitamos Todos os Cartões



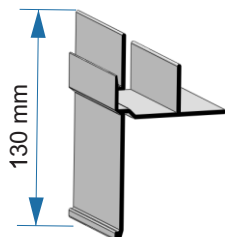

Saia 130
50.01.168

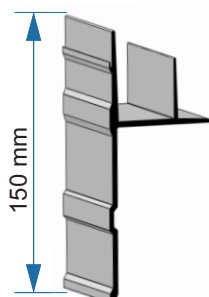

Saia 150
50.05.003

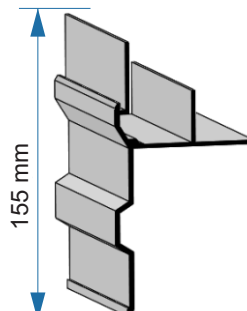

Saia 155
50.05.002

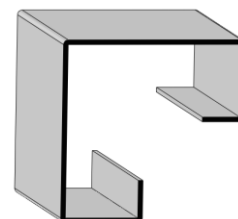

Coluna
50.05.022

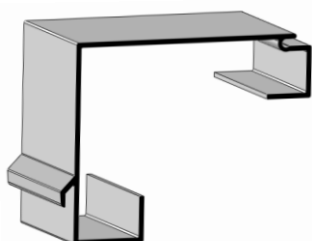

Coluna
50.05.020



Fechamento
50.05.025



Fechamento
50.05.026



Contorno do teto
50.05.015

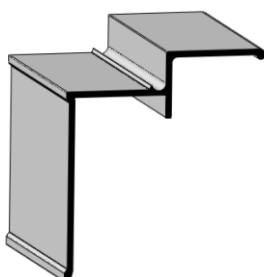

Longarina Superior
50.05.011

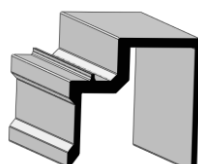

Longarina Superior
50.05.010



Perfil Z
50.02.045



Perfil Vígula
50.02.050



Contorno de Porta
50.05.030

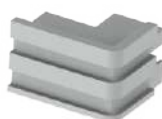

Canto Inferior Frontal ID
D - 99.00.141
E - 99.00.142



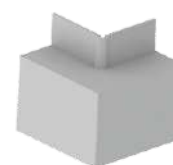

Canto inferior ID
99.00.130







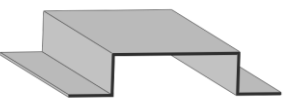
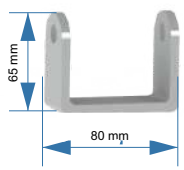





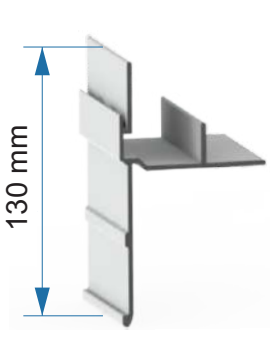
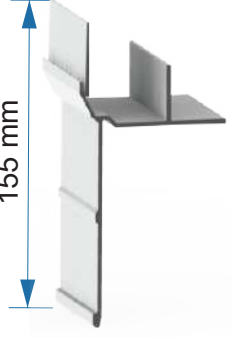



Canto Superior ID
99.00.685

 <p>Canto Superior 99.00.135</p>	 <p>Travessa inferior 99.00.617</p>	 <p>Travessa 99.00.723</p>	 <p>Coluna Traseira 99.00.722</p>
 <p>Calha 99.00.724</p>	 <p>Borracha ID 99.00.033</p>	 <p>Caixa do Came D - 11.00.003 E - 11.00.004</p>	 <p>Cavalete 99.00.380</p>
 <p>Came D - 11.00.001 E - 11.00.002</p>	 <p>Lingueta F.F D - 11.00.005 E - 11.00.006</p>	 <p>Castanha Curt. e Long. C - 11.00.008 L - 11.00.007</p>	 <p>Sup. da Alav. GRD. e PEQ. G - 10.00.002 P - 10.00.007</p>
 <p>Alavanca GRD. e PEQ. G - 10.00.001 P - 10.00.006</p>	 <p>Pino da Alavanca 1/2 - 10.00.003 3/8 - 10.00.008</p>	 <p>Trava Alavanca GRD. e PEQ. G - 10.00.004 P - 10.00.009</p>	 <p>Tramela GRD. e PEQ. G - 10.00.005 P - 10.00.010</p>

 <p>Base do Mancal 3/4 - 10.00.012 1" - 10.00.014</p>	 <p>Mancal 3/4 - 10.00.011 1" - 10.00.013</p>	 <p>Guia do Came 10.00.025</p>	 <p>Bandeja de Alumínio G - 99.00.099 P - 10.00.026</p>
 <p>Manete Menor AG 10.00.028</p>	 <p>Manete Maior AG 99.00.098</p>	 <p>Bico de Papagaio 10.00.030</p>	 <p>Pino da Dobradiça 90 mm - 10.00.019 95 mm - 10.00.020</p>
 <p>Varão 25 mm - 99.00.015 32 mm - 99.00.006</p>	 <p>Trava Porta Femea 10.00.018</p>	 <p>Trava Porta Macho 10.00.017</p>	 <p>Dobradiça Tras. 99.00.281</p> <p>250 mm 65 mm</p>
 <p>Dobradiça Lateral 99.00.448</p> <p>250 mm 65 mm</p>	 <p>Contra Pino 1/8X1" - 99.00.257 3/16X2" - 13.00.003 1/8X1.1/2 - 99.00.256 1/8 2 1/2 - 99.00.745</p>	 <p>Pino Elastico 5x26 cod. 99.00.219 5x32 cod. 99.00.254 6x26 cod. 99.00.171 6x32 cod. 99.00.255</p>	 <p>Anel de encosto 1" - 10.00.016 3/4 - 10.00.015</p>

 <p>Cartola de Porta 100 mm - 20.00.007 140 mm - 99.00.549</p>	 <p>Cavalete 10.02.012</p>	 <p>Castanha ID 99.00.059</p>	 <p>Cartola AG 99.00.061</p>
 <p>Cartola Curvada 99.00.111</p>	 <p>Batente de Porta 99.00.880</p>	 <p>Chapa Frisada 99.20.001</p>	 <p>Chapa Lisa Branca 99.00.003</p>
 <p>Chapa Lisa 99.00.010</p>	 <p>Chapa do Teto Interiça 10.20.003</p>	<p>Aceitamos todos os cartões</p>  	<p>Aceitamos cartão</p> 

**SUA FROTA EM BOAS MÃOS
TRABALHAMOS COM PRODUTOS
DE PRIMEIRA LINHA**

 <p>130 mm</p> <p>Saia 130 99.00.365</p>	 <p>155 mm</p> <p>Saia 155 99.00.364</p>	 <p>Coluna 99.00.261</p>	 <p>Fechamento 50.04.025</p>
 <p>Cartola AG 99.00.061</p>	 <p>Contorno de Teto 50.08.015</p>	 <p>Longarina 99.00.581</p>	 <p>Perfil Vígula 50.02.050</p>
 <p>Contorno de Porta 20.07.030</p>	 <p>Canto Maxfort 99.00.262</p>	 <p>Borracha 99.00.058</p>	 <p>Came D - 11.00.001 E - 11.00.002</p>
 <p>Lingueta Serie Lev. e Pes. Leve - 99.00.308 Pesado - 99.00.115</p>	 <p>Castan. Serie Leve e Pes. Leve - 99.00.309 Pesado - 99.00.116</p>	 <p>Sup. da Alav. GRD. e PEQ. G - 10.00.002 P - 10.00.007</p>	 <p>Alavanca GRD. e PEQ. G - 10.00.001 P - 10.00.006</p>

 <p>Pino da Alavanca 1/2 - 10.00.003 3/8 - 10.00.008</p>	 <p>Trava Alavanca GRD. e PEQ. G - 10.00.004 P - 10.00.009</p>	 <p>Tramela GRD. e PEQ. G - 10.00.005 P - 10.00.010</p>	 <p>Base e Mancal GRD e PEQ P - 99.00.060 G - 99.00.002</p>
 <p>Guia do Came 10.00.025</p>	 <p>Bandeja de Alumínio G - 99.00.099 P - 10.00.026</p>	 <p>Manete Menor AG 10.00.028</p>	 <p>Manete Maior AG 99.00.098</p>
 <p>Bico de Papagaio 10.00.030</p>	 <p>Pino da Dobradiça 90 mm - 10.00.019 95 mm - 10.00.020</p>	 <p>Varão 25 mm - 99.00.015 32 mm - 99.00.006</p>	 <p>Trava Porta Femea 10.00.018</p>
 <p>Trava Porta Macho 10.00.017</p>	 <p>Dobradiça Tras. 10.02.001</p>	 <p>Dobradiça Lateral 10.02.003</p>	 <p>Contra Pino 1/8X1" - 99.00.257 3/16X2" - 13.00.003 1/8X1.1/2 - 99.00.256 1/8 2 1/2 - 99.00.745</p>



Pino Elastico
5x26 cod. 99.00.219
5x32 cod. 99.00.254
6x26 cod. 99.00.171
6x32 cod. 99.00.255



Anel Encosto
1" - 10.00.016
3/4 - 10.00.015



Plug de Plastico
99.00.001

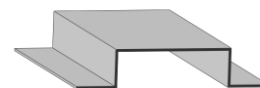

Cartola de Porta
100 mm - 20.00.007
140 mm - 99.00.549

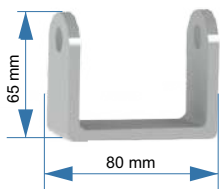

Cavalete
10.02.010

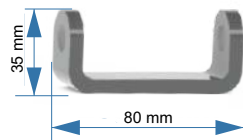

Cavalete
10.02.012



Cartola Curvada
99.00.111

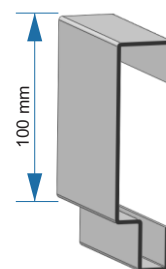

Coluna Q. Lat.100 mm
99.00.027

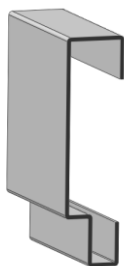

Travessa Sup. Quad. Lat
99.00.029

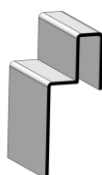

Travessa Inf. Quad. Lat
99.00.613

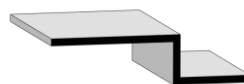

Batente de Porta
Galv. Cod - 99.00.374
Alumi. Cod - 50.02.035



Chapa Lisa Branca
99.00.003



Chapa Lisa
99.00.010

Aceitamos Todos os Cartões



Aceitamos cartão



Aceitamos Todos os Cartões



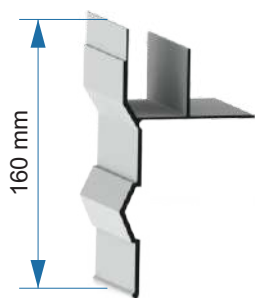

Saia 160
99.00.233



Coluna
50.01.365

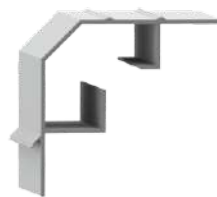

Coluna
99.00.258

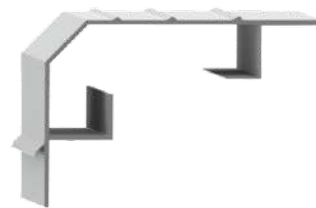

Coluna SP
99.00.096



Fechamento
50.02.025



Cartola
99.00.220



Cartola de AG
99.00.061



Contorno de Teto
50.02.015



Longarina Superior
50.02.010



Perfil Z
50.02.045



Perfil Vígula
50.02.050



Perfil J
50.07.050

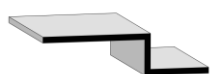

Batente de Porta
Galv. Cod - 99.00.374
Alumi. Cod - 50.02.035



Borracha
99.00.007



Came
D - 11.00.001
E - 11.00.002



Lingueta F.F
D - 11.00.005
E - 11.00.006



Castanha Curt. e Long.
C - 11.00.008
L - 11.00.007

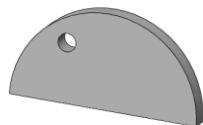

Sup. da Alavanca Meia Lua
99.00.463



Alavanca Alumínio
99.00.039



Trava da Alavança
99.00.129



Tramela Alumínio
99.00.118



Base do Mancal
3/4 - 10.00.012
1" - 10.00.014



Mancal
3/4 - 10.00.011
1" - 10.00.013



Guia do Came
10.00.025



Bandeja de Alumínio
G - 99.00.099
P - 10.00.026



Bandeja com Gatilho
99.00.191



Gatilho
99.00.486

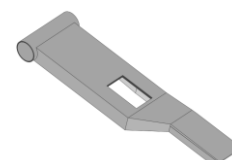

Manete Menor AG
10.00.028



Manete Maior AG
99.00.098







Manete
99.00.271



Bico de Papagaio
10.00.030

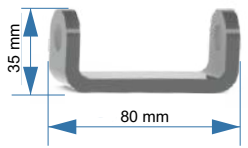
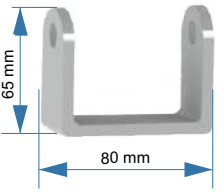

Pino da Dobradiça
90 mm - 10.00.019
95 mm - 10.00.020

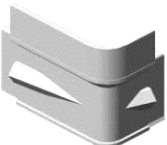
 <p>Varão 25 mm - 99.00.015 32 mm - 99.00.006</p>	 <p>Trava Porta Femea 10.00.018</p>	 <p>Trava Porta Macho 10.00.017</p>	 <p>Dobradiça Tras. 10.02.001</p>
 <p>Dobradiça Lateral 10.02.003</p>	 <p>Contra Pino 1/8X1" - 99.00.257 3/16X2" - 13.00.003 1/8X1.1/2 - 99.00.256 1/8 2 1/2 - 99.00.745</p>	 <p>Pino Elastico 5x26 cod. 99.00.219 5X32 cod. 99.00.254 6x26 cod. 99.00.171 6x32 cod. 99.00.255</p>	 <p>Anel encosto 1" - 10.00.016 3/4 - 10.00.015</p>
 <p>Plug de Plastico 99.00.001</p>	 <p>Cartola de Porta 100 mm - 20.00.007 140 mm - 99.00.549</p>	 <p>Cartola Curvada 99.00.111</p>	 <p>Cavelete Lateral 10.02.012</p>
 <p>Cavelete Reto 10.02.010</p>	 <p>Canto Superior Leve de Nylon ou Alum. Nylon - D - 99.00.315 Nylon - E - 99.00.316 Alumi - D - 99.00.044 Alumi - E - 99.00.045</p>	 <p>Canto CB Superior Pesado de Nylon ou Alum. Nylon - D - 99.00.312 Nylon - E - 99.00.313 Alumi. - D - 99.00.737 Alumi. - E - 99.00.738</p>	 <p>Canto Metalcar D - 99.00.282 E - 99.00.283</p>

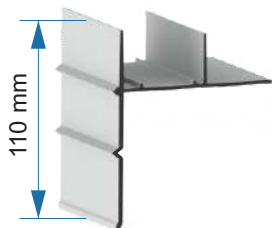

Saia 110
50.13.001

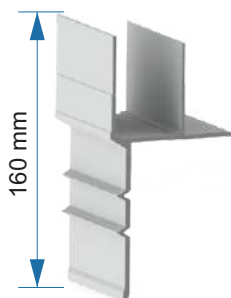

Saia 160
50.13.002

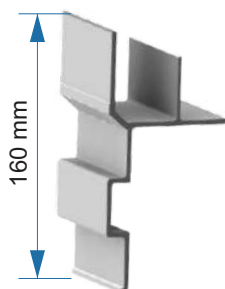

Saia 160
50.03.002

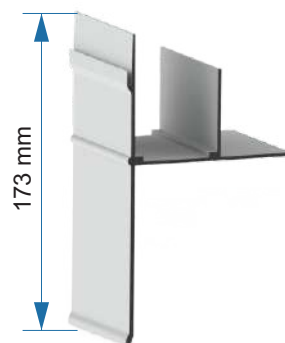

Saia 173
50.13.003



Coluna Frontal
50.13.020



Fechamento Frontal
50.01.025



Contorno do Teto
50.02.015



Longarina
50.02.010



Perfil Z 35mm
50.02.045



Cartola de Porta
100 mm - 20.00.007
140 mm - 99.00.549



Perfil Virgula
50.02.050



Perfil J
50.07.050



Contorno de Porta
50.02.030









Canto Cargo Van Inferior
D - 99.00.117
E - 99.00.175

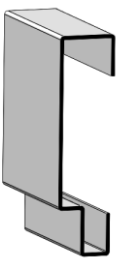
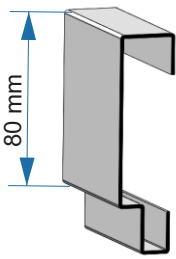
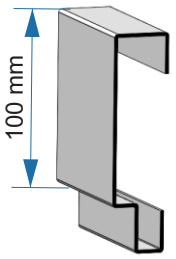
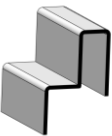
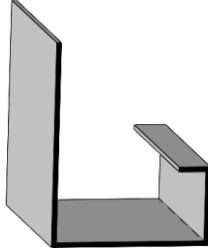
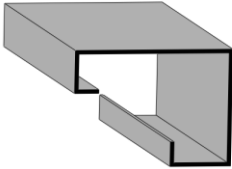
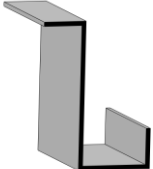
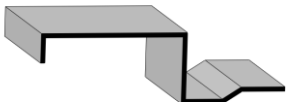

Canto Cargo van Inf.
D - 99.00.106
E - 99.00.107

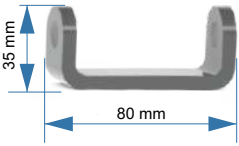

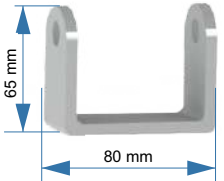
Canto Cargo Van Traseiro
D - 99.00.736
E - 99.00.100

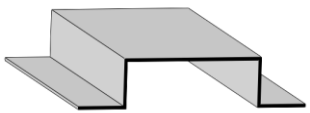
 <p>Canto CV Alumi. ou Nylon Alumi. - D - 99.00.737 Alumi. - E - 99.00.738 Nylon. - D - 99.00.312 Nylon. - E - 99.00.313</p>	 <p>Travessa Superior 99.00.029</p>	 <p>Coluna Q.Lat. 80mm 99.00.026</p>	 <p>Coluna Q. Lat.100mm 99.00.027</p>
 <p>Travessa Inferior 99.00.028</p>	 <p>Coluna Traseira 99.00.038</p>	 <p>Travessa Inferior 99.00.611</p>	 <p>Trave. Sup. do Qua. Tras. 99.00.193</p>
 <p>Perfil Calha 99.00.192</p>	 <p>Came D - 11.00.001 E - 11.00.002</p>	 <p>Caixa do Came D - 11.00.003 E - 11.00.004</p>	 <p>Cavalete Lateral 10.02.012</p>
 <p>Cavalete Inclinado 10.02.011</p>	 <p>Cavalete Reto 10.02.010</p>	 <p>Lingueta F.F D - 11.00.005 E - 11.00.006</p>	 <p>Cartola de Porta AG 100 mm - 20.00.007 140 mm - 99.00.549</p>

 <p>Castanha Curta e Longa C - 11.00.008 L - 11.00.007</p>	 <p>Sup. da alava. Meia Lua 99.00.463</p>	 <p>Alavanca de Alumínio 99.00.039</p>	 <p>Trava da Alavança 99.00.129</p>
 <p>Tramela Alumínio 99.00.118</p>	 <p>Base do Mancal 3/4 - 10.00.012 1" - 10.00.014</p>	 <p>Mancal 3/4 - 10.00.011 1" - 10.00.013</p>	 <p>Guia do Came 10.00.025</p>
 <p>Bandeja de Alumínio G - 99.00.099 P - 10.00.026</p>	 <p>Bandeja com Gatilho 99.00.191</p>	 <p>Gatilho Mapinha 99.00.486</p>	 <p>Manete Menor AG 10.00.028</p>
 <p>Manete Maior AG 99.00.098</p>	 <p>Manete 99.00.271</p>	 <p>Bico de Papagaio 10.00.030</p>	 <p>Pino da Dobradiça 90 mm - 10.00.019 95 mm - 10.00.020</p>

 <p>Varão 25 mm - 99.00.015 32 mm - 99.00.006</p>	 <p>Trava Porta Femea 10.00.018</p>	 <p>Trava Porta Macho 10.00.017</p>	 <p>Dobradiça Tras. 10.02.001</p>
 <p>Dobradiça Lateral 10.02.003</p>	 <p>Contra Pino 1/8X1" - 99.00.257 3/16X2" - 13.00.003 1/8X1.1/2 - 99.00.256 1/8 2 1/2 - 99.00.745</p>	 <p>Pino Elastico 5x26 cod. 99.00.219 5x32 cod. 99.00.254 6x26 cod. 99.00.171 6x32 cod. 99.00.255</p>	 <p>Anel de Encosto 1" - 10.00.016 3/4 - 10.00.015</p>
 <p>Plug de Plastico 99.00.001</p>	 <p>Cartola Galv. Curvada 99.00.111</p>	 <p>Borracha CV 99.00.007</p>	 <p>Borracha CV Com Aba 99.00.649</p>
 <p>Batente de Porta Galv. Cod - 99.00.374 Alumi. Cod - 50.02.035</p>	 <p>Chapa Lisa 99.00.010</p>	 <p>Chapa Frisada 99.20.001</p>	<p>Aceitamos todos os cartões</p>  

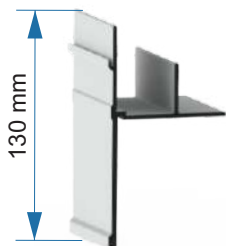

Saia 130
50.07.001

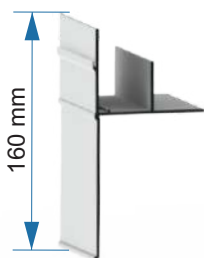

Saia 160
50.07.002

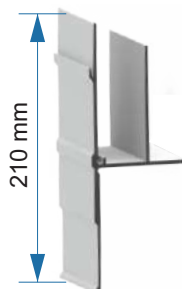

Saia 210 Antinga
50.07.003

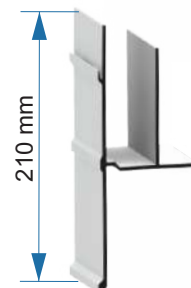

Saia 210 Nova
50.07.004



Coluna Frontal
50.07.020

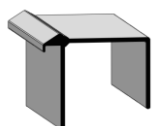

Fechamento
50.07.025



Cartola Larga
50.07.041



Cartola de AG
99.00.061

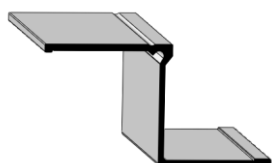

Contorno de Teto
50.07.015

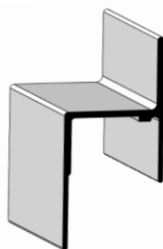

Longarina
50.07.010



Perfil Z
50.07.045



Perfil J
50.07.050



Contorno de Porta
50.07.030









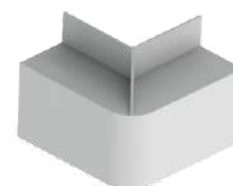



Canto RD Frontal Alto
99.00.043

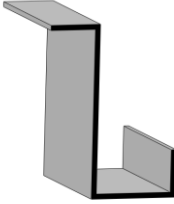
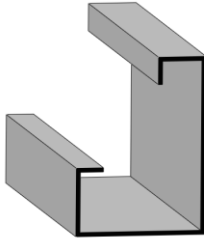
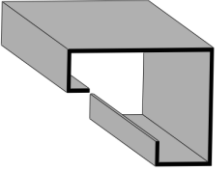

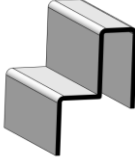
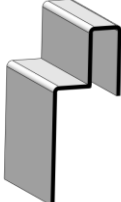
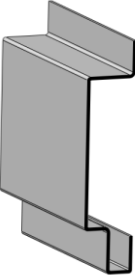

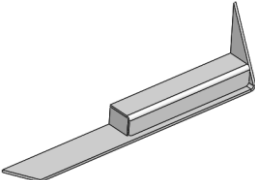



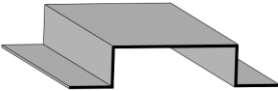







Canto RD Inf. Baixo
99.00.267

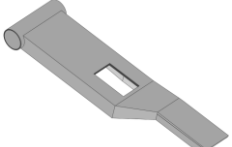

Canto RD Sup. Alumin. e Nylon
Alumin - 99.00.041
Nylon - 99.00.311

 <p>Canto RD Inf. Novo 99.00.487</p>	 <p>Canto RD Superior Novo 99.00.455</p>	 <p>Travessa Superior 99.00.726</p>	 <p>Coluna Traseira 99.00.725</p>
 <p>Travessa Inferior 99.00.728</p>	 <p>Batente de Porta 99.00.648</p>	 <p>Trav. Inf. do Q. Lat. Estreito 99.00.028</p>	 <p>Trav. Inf. do Q. Lat. largo 99.00.613</p>
 <p>Travessa Sup. do Qua. Lat. 99.00.729</p>	 <p>Coluna do Quadro Lat. 99.00.377</p>	 <p>Batente do Q. Tras RD D - 41.07.002 E - 41.07.001</p>	 <p>60 mm</p> <p>Cavalete Traseiro 10.07.010</p>
 <p>Borracha RD C/ Aba 99.00.349</p>	 <p>Borracha RD 99.00.348</p>	 <p>Borracha Sem Aba 99.00.058</p>	 <p>Cartola de Porta 110 mm - 74.07.019 160 mm - 74.07.020</p>

 <p>Caixa do Came D - 11.00.003 E - 11.00.004</p>	 <p>Came D - 11.00.001 E - 11.00.002</p>	 <p>Lingueta F.F 99.00.158</p>	 <p>Castanha 99.00.157</p>
 <p>Sup. da Alav. GRD. e PEQ. G - 10.00.002 P - 10.00.007</p>	 <p>Alavanca GRD. e PEQ. G - 10.00.001 P - 10.00.006</p>	 <p>Pino da Alavanca 1/2.10.00.003 3/8.10.00.008</p>	 <p>Trava Alavan. GRD. e PEQ. G - 10.00.004 P - 10.00.009</p>
 <p>Tramela GRD. e PEQ. G - 10.00.005 P - 10.00.010</p>	 <p>Base do Mancal 3/4 -10.00.012 1" -10.00.014</p>	 <p>Mancal 3/4 - 10.00.011 1. - 10.00.013</p>	 <p>Guia do Came 10.00.025</p>
 <p>Bandeja c/ Trinco e Chave 99.00.246</p>	 <p>Manete Menor AG 10.00.028</p>	 <p>Manete Maior AG 99.00.098</p>	 <p>Bandeja de Alumínio G - 99.00.099 P - 10.00.026</p>

 <p>Bico de Papagaio 10.00.030</p>	 <p>Pino da Dobradiça 90 mm - 10.00.019 95 mm - 10.00.020</p>	 <p>Varão 25 mm - 99.00.015 32 mm - 99.00.006</p>	 <p>Trava Porta Femea 10.00.018</p>
 <p>Trava Porta Macho 10.00.017</p>	 <p>280 mm 68 mm</p> <p>Dobradiça Tras. RD 10.07.001</p>	 <p>Dobradiça Lateral RD 10.07.002</p>	 <p>Dobradiça RD Retã 10.07.003</p>
 <p>Contra Pino 1/8X1" - 99.00.257 3/16X2" - 13.00.003 1/8X1.1/2 - 99.00.256 1/8 2 1/2 - 99.00.745</p>	 <p>Pino Elastico 5x26 cod. 99.00.219 5x32 cod. 99.00.254 6x26 cod. 99.00.171 6x32 cod. 99.00.255</p>	 <p>Anel de encosto 1" - 10.00.016 3/4 - 10.00.015</p>	 <p>Trava Pallet RD 20.07.001</p>
 <p>Plug de Plastico 99.00.001</p>	 <p>Entrada de ar RD 99.00.362</p>	 <p>Aleta RD Com Friso - 99.00.073 Sem Friso - 17.07.010</p>	 <p>Chapa de Aluminio 99.00.010 1250 mm</p>

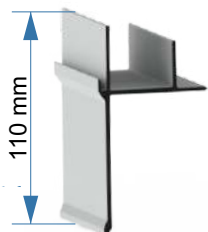

Saia 110
50.04.001



Coluna
50.04.020

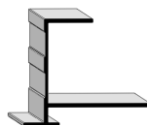

Fechamento Novo
50.04.026



Fechamento
50.05.026

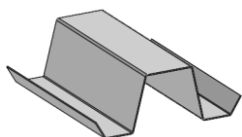

Cartola
71.20.005

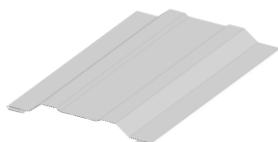

Ripa
71.20.006

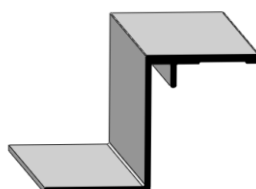

Contorno de Teto
50.04.015



Longarina
50.02.010



Perfil Vígula
50.02.050



Contorno de Porta
50.07.030



Canto
99.00.859

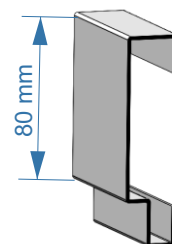

Coluna Q. Lat. 80 mm
99.00.026

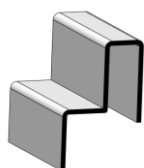

Travessa Inferior
99.00.028

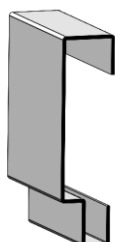

Travessa Sup. Quadro Lat
99.00.029

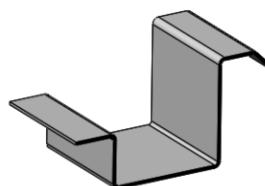

Calha
71.20.003

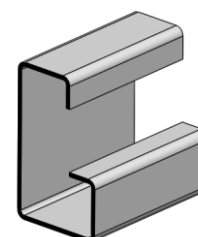

Coluna Traseira
71.20.001

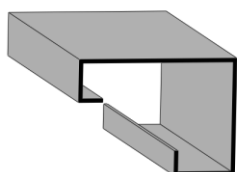

Travessa Inferior
71.20.002

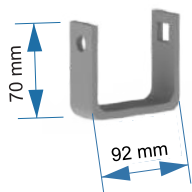

Cavelete Tras.
10.04.011



Borracha Sem Aba
99.00.058

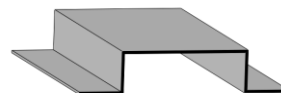

Cartola de Porta
110 mm - 74.07.019
160 mm - 74.07.020



Caixa do Came
D - 11.00.003
E - 11.00.004



Came
D - 11.00.001
E - 11.00.002

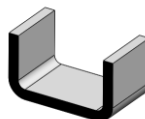

Castanha
G - 11.00.001
P - 11.00.001

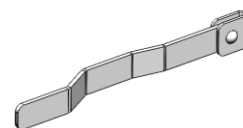

Cj Alavanca GRD e PEQ
G - 61.00.006
P - 61.00.005



Trava Alavan. GRD. e PEQ.
G - 10.00.004
P - 10.00.009



Tramela GRD. e PEQ.
G - 10.00.005
P - 10.00.010



Base do Mancal
3/4 - 10.00.012
1" - 10.00.014



Mancal
3/4 - 10.00.011
1. - 10.00.013



Guia do Came
10.00.025

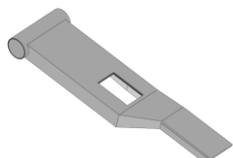

Manete Menor AG
10.00.028



Bandeja de Aluminio
G - 99.00.099
P - 10.00.026



Bico de Papagaio
10.00.030



Pino da Dobradiça
100 mm - 10.00.173



Varão
25 mm - 99.00.015
32 mm - 99.00.006



Trava Porta Femea
10.00.018



Trava Porta Macho
10.00.017



Dobradiça Tras. RD
10.07.001

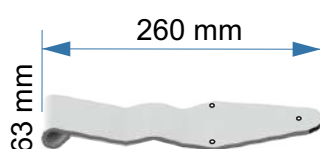

Dobradiça Tras.
10.02.001



Pino Elastico
5x26 cod. 99.00.219
5x32 cod. 99.00.254
6x26 cod. 99.00.171
6x32 cod. 99.00.255



Contra Pino
1/8X1" - 99.00.257
3/16X2" - 13.00.003
1/8X1.1/2 - 99.00.256
1/8 2 1/2 - 99.00.745



Anel de encosto
1" - 10.00.016
3/4 - 10.00.015



Plug de Plastico
99.00.001



Chapa Lisa Branca
99.00.003

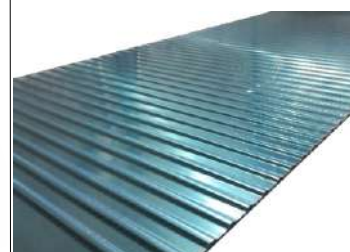

Chapa Frisada
99.20.001



Chapa Lisa
99.00.010

Aceitamos cartão





DOBRE EIXO[®]

PEÇAS PARA BAÚS E SIDER

Lealdade em Negócios

SERVIÇOS



CORTE Á PLASMA

Qualidade, Eficiência, Tecnologia, Segurança, Criatividade, Economia e Agilidade. Cortes padronizados dispensando a preparação prévia com uma ótima produtividade



CORTE E DOBRA

corte e dobra de chapas metálicas, produzimos perfis especiais conforme amostra ou desenho.



PERFILADEIRA

Fabricação de perfilados com alta resistência e durabilidade.

WWW.DOBREEIXO.COM.BR

(11) 2087 - 5322

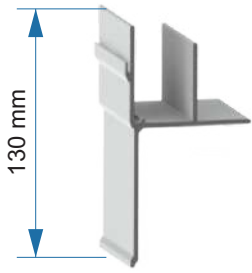

Saia 130
50.01.002

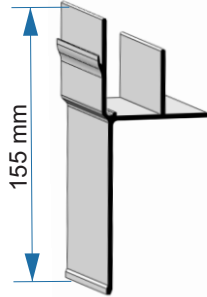

Saia Nova 155 mm
50.01.004

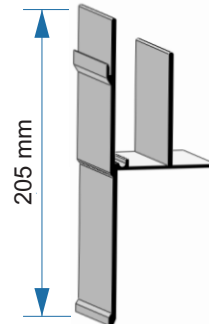

Saia 205 mm
50.01.005

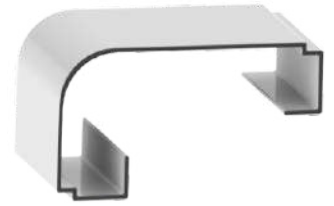

Coluna Frontal
99.00.211

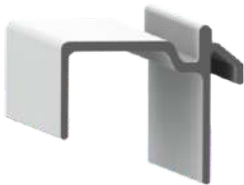

Fechamento Frontal
50.01.025



Fechamento
99.00.212



Cartola AG
99.00.061



Contorno do Teto
50.01.015



Longarina
99.00.225



Longarina
50.01.010



Perfil Z 35mm
50.02.045



Perfil Vígula
50.02.050



Perfil J
99.07.050

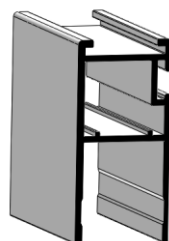

Contorno de Porta Injetada
99.00.523



Cartola RF
99.00.121



Cartola RF AG
20.00.004



Canto RF Superior
99.00.579



Canto RF Superior
99.00.420



Borracha RF
99.00.446



Borracha RF Batente
99.00.424

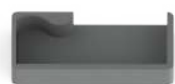

Caixa do Came
D - 11.00.003
E - 11.00.004

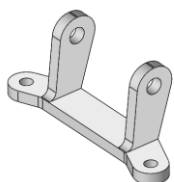

Cavalete
99.00.466



Ripa Galvanizada
99.00.661



Came
D.11.00.001
E.11.00.002



Lingueta F.F
D - 11.00.005
E - 11.00.006



Castanha Curt. e Long.
C - 11.00.008
L - 11.00.007



Sup. da Alav. GRD. e PEQ.
G - 10.00.002
P - 10.00.007



Alavanca GRD. e PEQ.
G - 10.00.001
P - 10.00.006



Pino da Alavanca
1/2 - 10.00.003
3/8 - 10.00.008



Alavanca
99.00.372



Lingueta RF
99.00.593



Base da Alavanca
99.00.350

 <p>Batente de Porta Galv. Cod - 99.00.374 Alumi. Cod - 50.02.035</p>	 <p>Dobradiça Tras. 10.02.001</p>	 <p>Dobradiça Lateral 10.02.003</p>	 <p>Dobradiça RF 99.00.206</p>
 <p>Reforço da Porta RF 99.00.572</p>	 <p>Contra Pino 1/8X1" - 99.00.257 3/16X2" - 13.00.003 1/8X1.1/2 - 99.00.256 1/8 2 1/2 - 99.00.745</p>	 <p>Pino Elastico 5x26 cod. 99.00.219 5x32 cod. 99.00.254 6x26 cod. 99.00.171 6x32 cod. 99.00.255</p>	 <p>Anel de encosto 1" - 10.00.016 3/4 - 10.00.015</p>
 <p>Cartola de Porta 120 mm - 20.00.007 160 mm - 99.00.549</p>	 <p>Coluna frontal 50.01.020</p>	 <p>Contorno de Porta 99.00.639</p>	 <p>Borracha 99.00.346</p>
 <p>Cavalete Lateral 99.00.279</p>	 <p>Cavalete Traseiro 99.00.183</p>	 <p>Cartola Curvada 99.00.111</p>	 <p>Trava Porta Femea 10.00.018</p>



Trava Porta Macho
10.00.017



Castanha Inf. Coluna Movél
99.00.574



Trava Inf. Coluna Movél
99.00.573



Trava GRD. e PEQ.
G - 10.00.004
P - 10.00.009



Tramela GRD. e PEQ.
G - 10.00.005
P - 10.00.010



Base do Mancal
3/4 - 10.00.012
1" - 10.00.014



Mancal
3/4 - 10.00.011
1" - 10.00.013



Guia do Came
99.00.570

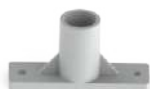

Guia do Came RF
99.00.571



Bandeja de Alumínio
G - 99.00.099
P - 10.00.026

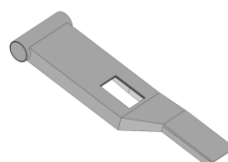

Manete Menor AG
10.00.028



Manete Maior AG
99.00.098



Bico de Papagaio
10.00.030



Pino da Dobradiça
90 mm - 10.00.019
95 mm - 10.00.020



Varão
25 mm - 99.00.015
32 mm - 99.00.006



Engate da Lingueta
99.00.592

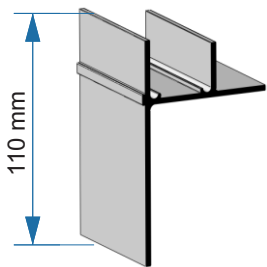

Saia 110
50.03.001

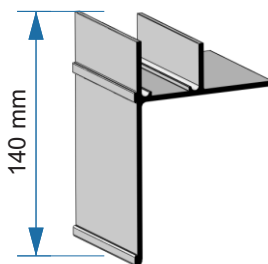

Saia 140
50.02.002

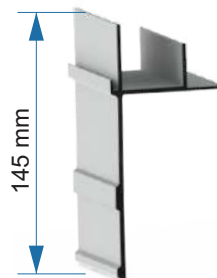

Saia 145
50.04.002

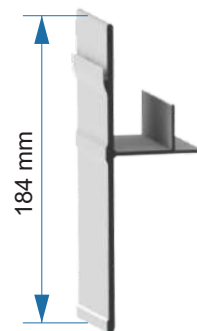

Saia 184
50.04.003



Coluna
50.03.020



Fechamento
50.02.025



Contorno de Teto
50.02.015



Longarina
50.02.010



Perfil Z
50.02.045



Perfil J
50.07.050



Perfil Vírgula
50.02.050



Contorno de Porta
50.02.030



Canto Superior Leve de
Nylon ou Alum.
Nylon - D - 99.00.315
Nylon - E - 99.00.316
Alumi - D - 99.00.044
Alumi - E - 99.00.045









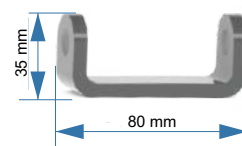



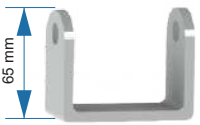



Borracha
99.00.007



Caixa do Came
D - 11.00.003
E - 11.00.004

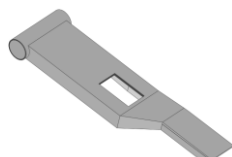

Cavalete Lateral
10.02.012

 <p>65 mm</p> <p>Cavalete Reto 10.02.010</p>	 <p>Came D - 11.00.001 E - 11.00.002</p>	 <p>Lingueta F.F D - 11.00.005 E - 11.00.006</p>	 <p>Castanha Curt. e Long. C - 11.00.008 L - 11.00.007</p>
 <p>Sup. da Alav. GRD.e PEQ. G - 10.00.002 P - 10.00.007</p>	 <p>Alavanca GRD. e PEQ. G - 10.00.001 P - 10.00.006</p>	 <p>Pino da Alavanca 1/2 - 10.00.003 3/8 - 10.00.008</p>	 <p>Trava Alavanca GRD e PEQ. G - 10.00.004 P - 10.00.009</p>
 <p>Tramela GRD. e PEQ. G - 10.00.005 P - 10.00.010</p>	 <p>Mancal 3/4 - 10.00.011 1" - 10.00.013</p>	 <p>Base do Mancal 3/4 - 10.00.012 1" - 10.00.014</p>	 <p>Guia do Came 10.00.025</p>
 <p>Bandeja de Aluminio G - 99.00.099 P - 10.00.026</p>	 <p>Manete Menor AG 10.00.028</p>	 <p>Manete Maior AG 99.00.098</p>	 <p>Bico de Papagaio 10.00.030</p>

 <p>Pino da Dobradiça 90 mm - 10.00.019 95 mm - 10.00.020</p>	 <p>Varão 25 mm - 99.00.015 32 mm - 99.00.006</p>	 <p>Trava Porta Femea 10.00.018</p>	 <p>Trava Porta Macho 10.00.017</p>
 <p>Dobradiça Tras. 10.02.001</p>	 <p>Dobradiça Lateral 10.02.003</p>	 <p>Dobradiça SP 71.21.010</p>	 <p>Pino Elastico 5x26 cod. 99.00.219 5x32 cod. 99.00.254 6x26 cod. 99.00.171 6x32 cod. 99.00.255</p>
 <p>Anel encosto 1" - 10.00.016 3/4 - 10.00.015</p>	 <p>Plug de Plastico 99.00.001</p>	 <p>Entrada de ar 99.00.362</p>	 <p>Contra Pino 1/8X1" - 99.00.257 3/16X2" - 13.00.003 1/8X1.1/2 - 99.00.256 1/8 2 1/2 - 99.00.745</p>
 <p>Cartola Curvada 99.00.111</p>	 <p>Batente de Porta Galv. Cod - 99.00.374 Alumi. Cod - 50.02.035</p>	 <p>Cartola de Porta 100 mm - 20.00.007 140 mm - 99.00.549</p>	 <p>Chapa de Aluminio 99.00.010</p>

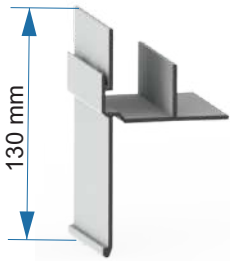

Saia 130
99.00.109

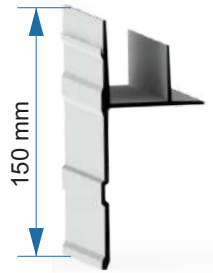

Saia 150
50.05.003

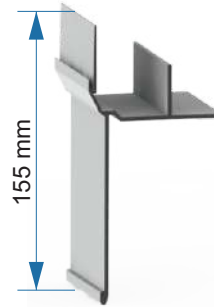

Saia 155
99.00.155

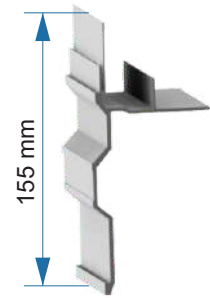

Saia 155 SP
50.05.002



Coluna Frontal
50.08.020



Fechamento
50.04.025



Contorno de Teto
50.08.015



Longarina
50.04.011



Cartola TV. Alumínio
99.00.220



Contorno de Porta
50.04.644



Canto TV
99.00.037



Borracha
99.00.007

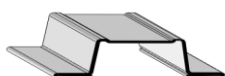

Ripa Galvanizada
99.00.661



Came
D - 11.00.001
E - 11.00.002



Lingueta F.F
D - 11.00.005
E - 11.00.006



Castanha Curt. e Long.
C - 11.00.008
L - 11.00.007



Sup. da Alav. Meia lua
99.00.463



Alavanca Alumínio
99.00.039



Trava da Alavança
99.00.129



Tramela Alumínio
99.00.118



Base do Mancal
3/4 - 10.00.012
1" - 10.00.014



Mancal
3/4 - 10.00.011
1" - 10.00.013



Guia do Came
10.00.025



Bandeja de Alumínio
G - 99.00.099
P - 10.00.026

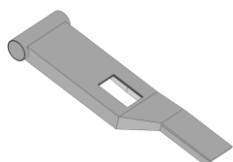

Manete Menor AG
10.00.028



Manete Maior AG
99.00.098



Manete
99.00.271



Bico de Papagaio
10.00.030



Pino da Dobradiça
90 mm - 10.00.019
95 mm - 10.00.020



Varão
25 mm - 99.00.015
32 mm - 99.00.006



Trava Porta Femea
10.00.018



Trava Porta Macho
10.00.017



 <p>Cartola Curvada 99.00.111</p>	 <p>Dobradiça Tras. 10.02.001</p>	 <p>Dobradiça Lateral 10.02.003</p>	 <p>Contra Pino 1/8X1" - 99.00.257 3/16X2" - 13.00.003 1/8X1.1/2 - 99.00.256 1/8 2 1/2 - 99.00.745</p>
 <p>Pino Elastico 5x26 cod. 99.00.219 5x32 cod. 99.00.254 6x26 cod. 99.00.171 6x32 cod. 99.00.255</p>	 <p>Anel Encosto 1" - 10.00.016 3/4 - 10.00.015</p>	 <p>Plug de Plastico 99.00.001</p>	 <p>Entrada de Ar 5 Frisos 99.00.679</p>
 <p>Batente de Porta Galv. Cod - 99.00.374 Alumi. Cod - 50.02.035</p>	 <p>Chapa de Alumínio 99.00.010</p>	 <p>Chapa Lisa Branca 99.00.003</p>	 <p>Cartola de Porta 100 mm - 20.00.007 140 mm - 99.00.549</p>
 <p>Cavalete Lateral 10.02.012</p>	 <p>Cavalete Reto 10.02.010</p>	 <p>Levanta Fio TV D - 74.08.001 E - 74.08.002</p>	<p>Aceitamos cartão</p> 



DOBRE EIXO[®]
PEÇAS PARA BAÚS E SIDER

Lealdade em Negócios

QUADROS

Quadro Lateral

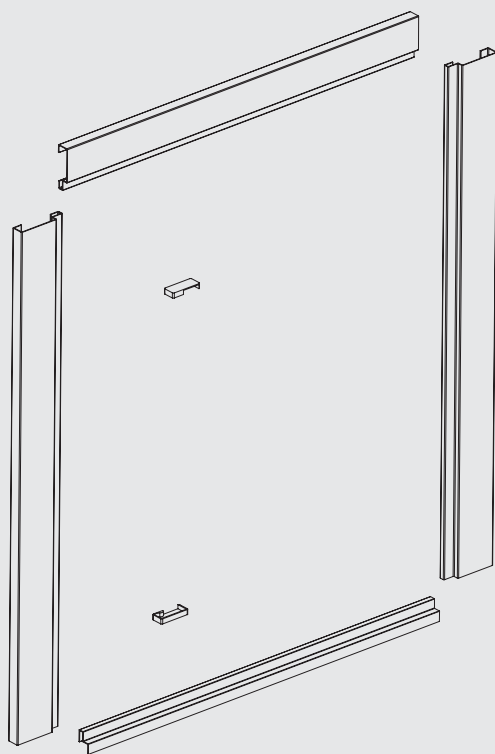

Quadro Traseiro

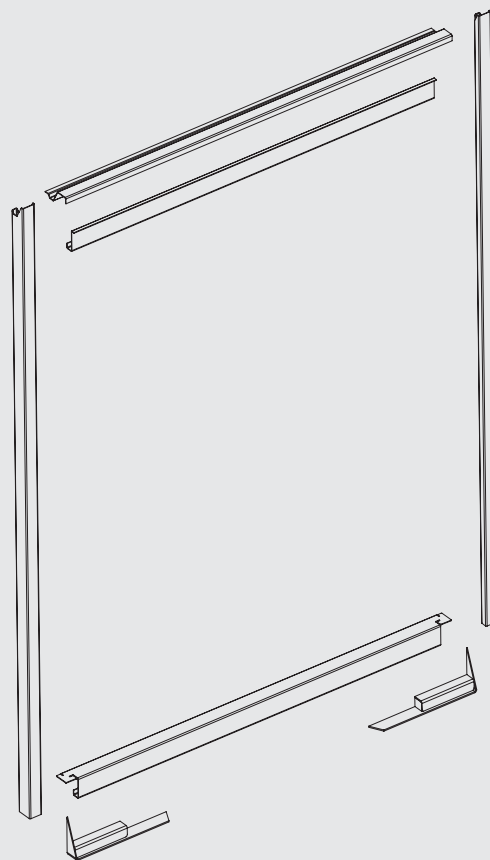

WWW.DOBREEIXO.COM.BR

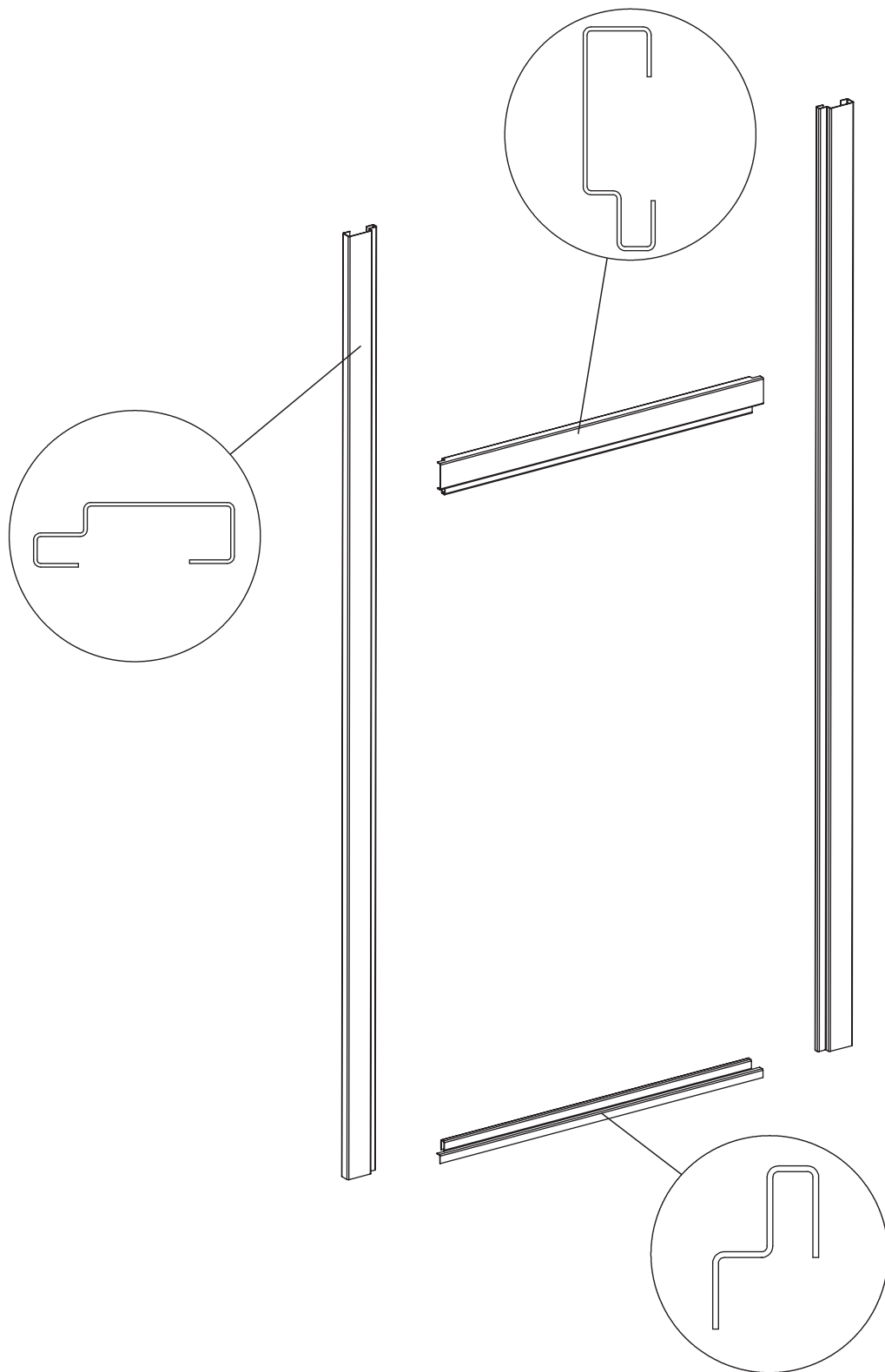

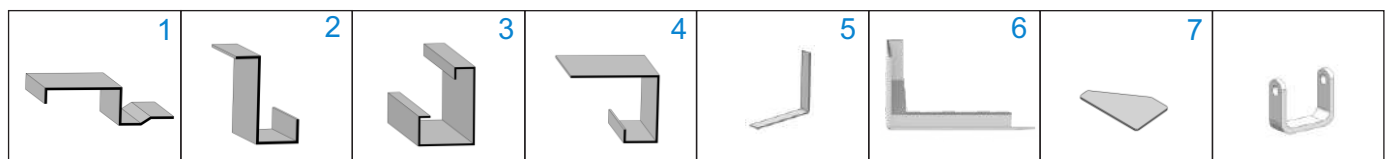
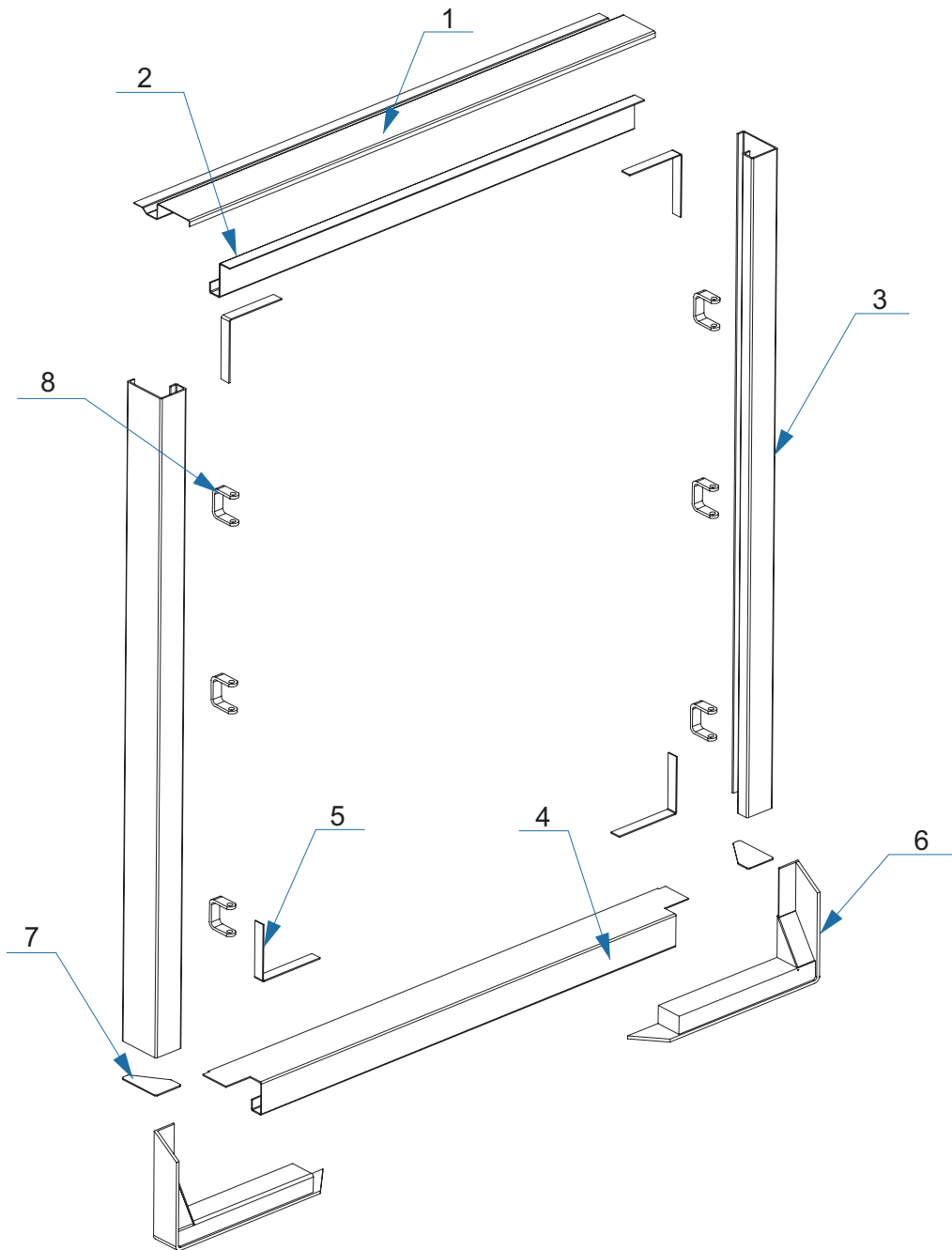

1 Calha

2 Travessa Sup.

3 Coluna

4 Travessa Inf.

5 Reforço

6 Reforço do Quad.

7 Tampa da Coluna

8 Cavalete



DOBRE EIXO[®]

PEÇAS PARA BAÚS E SIDER

Lealdade em Negócios

PORTA CONVENCIONAL

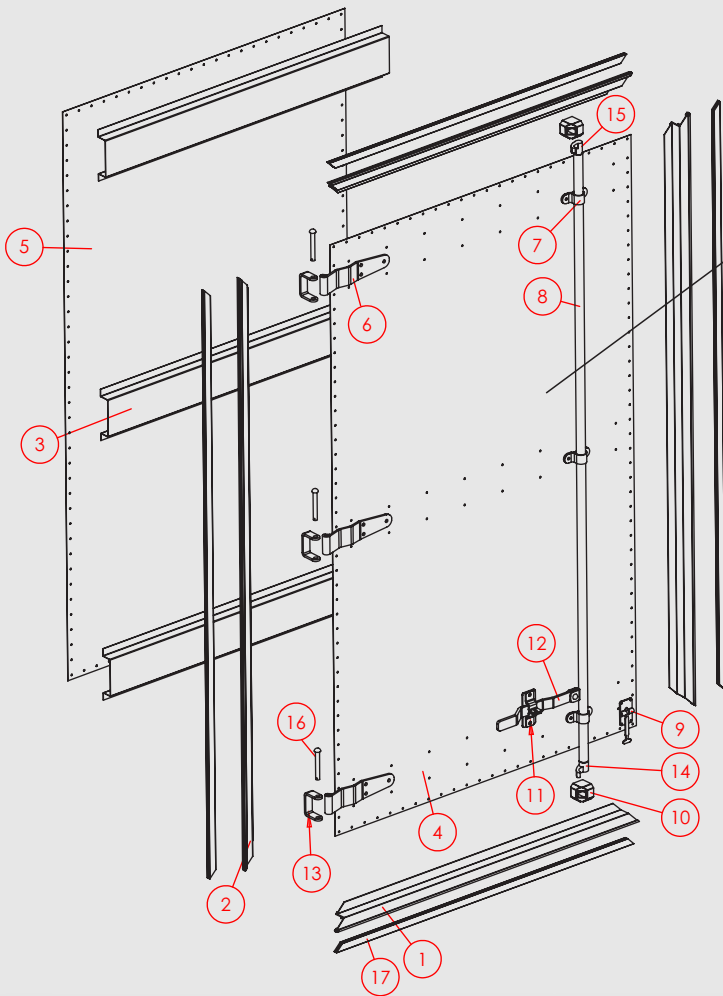

Nº DO ITEM	NOME DA PEÇA	QTD.
1	CONTORNO DE PORTA SUP. E INF.	2
2	CONTORNO DE PORTA LATERAL	2
3	CARTOLA DE PORTA	3
4	CHAPA LISA FRONTAL	1
5	CHAPA TRASEIRA DA PORTA	1
6	DOBRADIÇA	3
7	C.j MANCAL E BASE	3
8	VARÃO	1
9	TRAVA PORTA MACHO	1
10	CASTANHA	2
11	TRAVA ALAVANCA	1
12	C.j ALAVANCA	1
13	CAVALETE	3
14	LINGUETA ESQ.	1
15	LINGUETA DIR.	1
16	PINO	3
17	BORRACHA	1

WWW.DOBREEIXO.COM.BR

(11) 2087 - 5322

Porta com Chapa Frisada

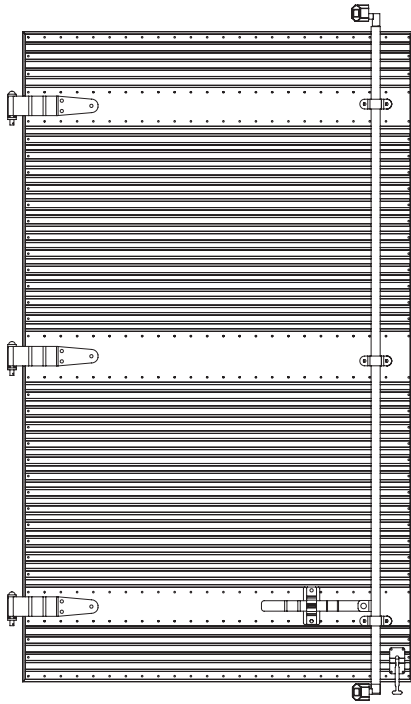

Porta com Varão Duplo

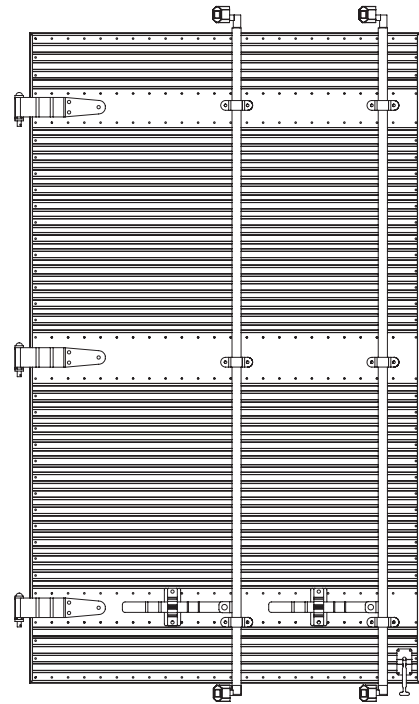

Porta com Chapa Lisa

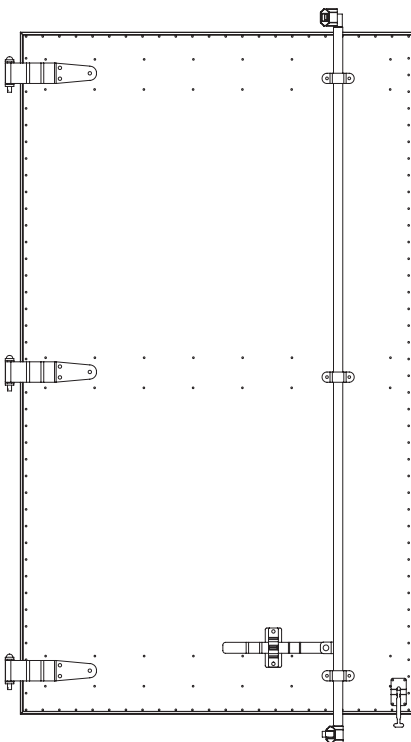

Porta com Varão Interno

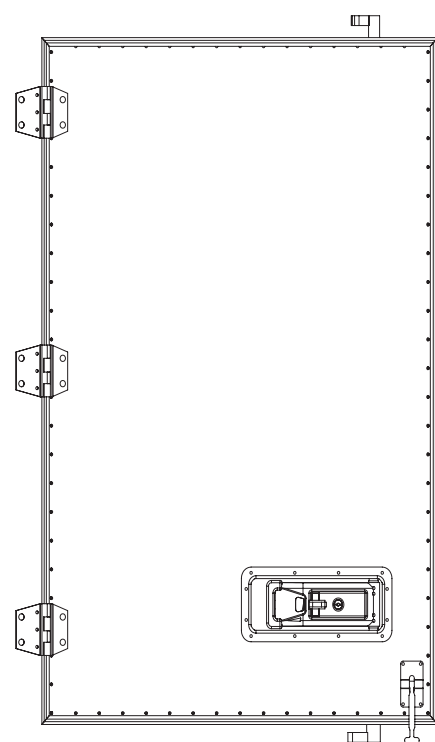



DOBRE EIXO[®]
PEÇAS PARA BAÚS E SIDER

Lealdade em Negócios

PEÇAS PARA SIDER

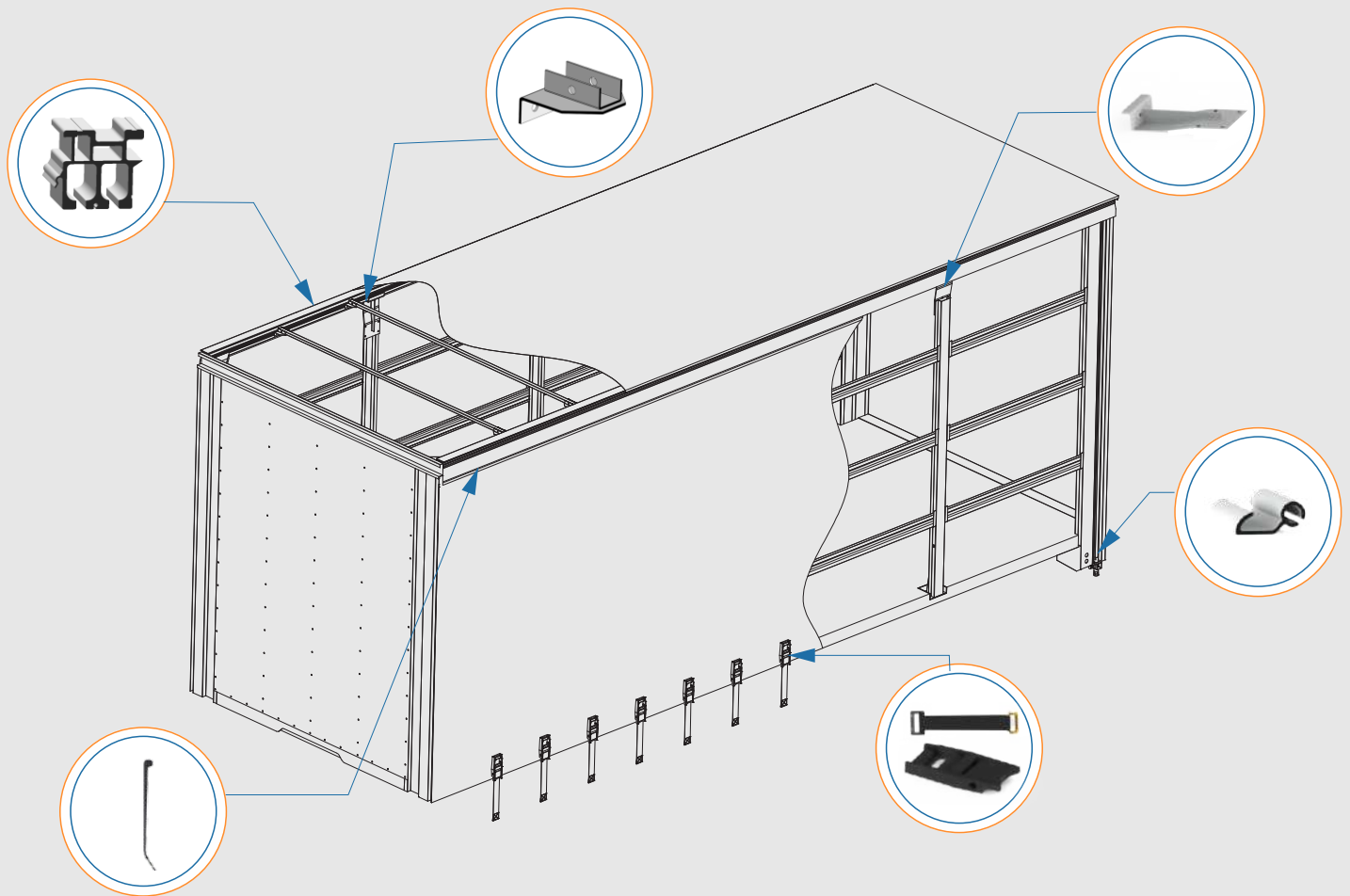

WWW.DOBREEIXO.COM.BR

(11) 2087 - 5322

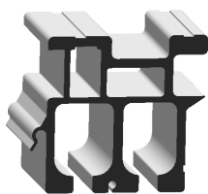

Trilho do Sider RD
99.00.180

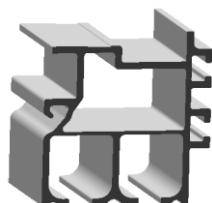

Trilho do Sider FC
99.00.659



Trilho Simples
99.00.359

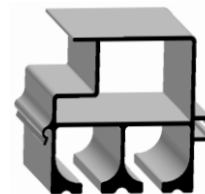

Trilho do Sider
50.00.050

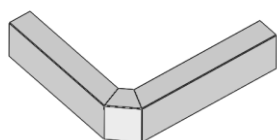

Canto do Sider chanfrado
D - 99.00.230
E - 99.00.231

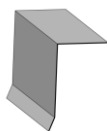

Cantoneira do Sider
99.00.829

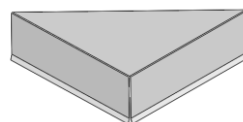

Canto superior
99.00.653

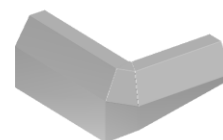

Canto do sider RD
D - 20.07.002
E - 20.07.003



Cantoneira do sider RD
20.07.004

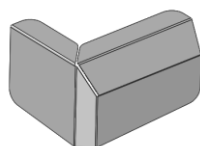

Canto do Sider RD novo
D - 70.07.019
E - 70.07.020



Esticador de Lona RD
99.00.076



Esticador de Lona RD
99.00.289



Esticador de Lona FC
99.00.222



Varão Esticador Igreja
99.00.358



Varão est. de lona redo.
10.00.049



Terminal. do esti. de lona RD
10.07.004



Terminal do Varão Igrej. Inf
99.00.522

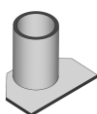

Terminal do Varão Igrej. Sup.
99.00.888



Gancho Garra
3/8 - 99.00.630
5/16 - 99.00.632

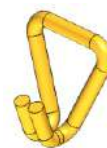

Gancho J
99.00.707

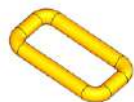

Gancho quadrado
10.00.468



Rabicho do Sider

99.00.666 - 320 mm
99.00.667 - 340 mm
99.00.080 - 360 mm
99.00.668 - 380 mm
99.00.669 - 400 mm
99.00.277 - 420 mm
70.00.110 - 440 mm
18.00.010 - 480 mm
78.00.515 - 500 mm



Fivela do Sider
99.00.092



Catraca Fixa
99.00.114

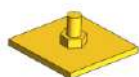

Chapa Deslocamento
99.00.654



Cinta de amarração

100x9MT - 18.00.011 - 10 Ton.
50x9MT - 99.00.853 - 1,5 Ton.
50x9MT - 99.00.854 - 3 Ton.



Cinta de Amarr. 50 x 9MT
99.00.088 - 1,5 Ton.
99.00.505 - 3 Ton.



Catraca Móvel C/ Gancho J
99.00.087



Rabicho da Fivela
99.00.205



Rabicho da catraca móvel
com gancho G
18.00.002



Rolo de Cinta CBB
99.00.634



Rabicho da catraca móvel
com gancho J
18.00.003



Catraca Fixa 100 mm
10.00.089

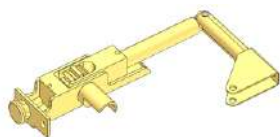

Catraca RD
D - 99.00.355
E - 99.00.356



Catraca Esp. P/ Cabo de Aço
99.00.305



Catraca Central lock
99.00.301



Catraca CR
99.00.300



Catraca TL
99.00.655



Catraca AN
99.00.302

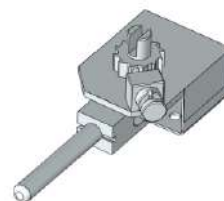

Catraca RD
D - 99.00.016
E - 99.00.017

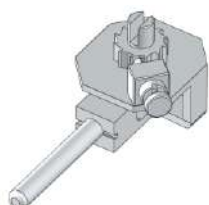

Catraca RD
D - 99.00.370
E - 99.00.371

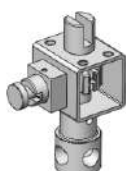

Catraca WR
99.00.079



Catraca WR Meia Lua
99.00.079

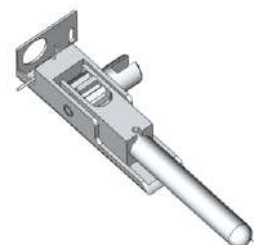

Catraca FC
D - 99.00.125
E - 99.00.126

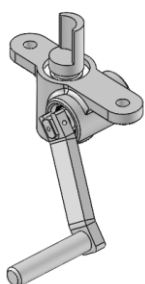

Catraca RD Manilha
D - 10.07.006
E - 10.07.005



Catraca Central Lock RD
10.07.098

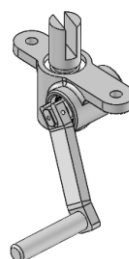

Catraca FC Manilha
D - 10.04.099
E - 10.04.100

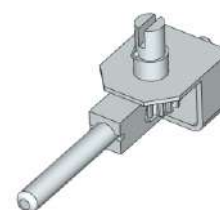

Catraca GR
99.00.299

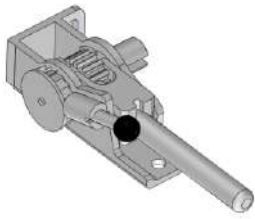

Catraca FC
D - 99.00.585
E - 99.00.586

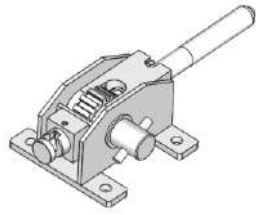

Catraca FC
D - 99.00.145
E - 99.00.146

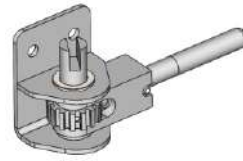

Catraca Dobre Eixo
40.10.001

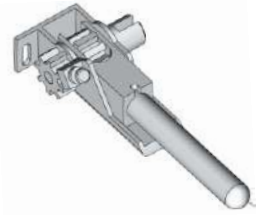

Catraca FC 2009 Sem Bolinha
D - 99.00.689
E - 99.00.690

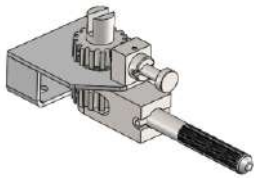

Catraca
40.00.015

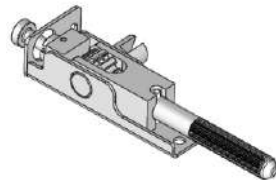

Catraca
D - 40.00.016
E - 40.00.017

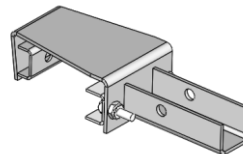

Sapata do teto tubular
44.00.006

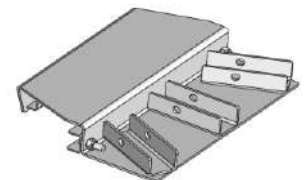

Sapata do teto tubu. Tripla
44.00.011

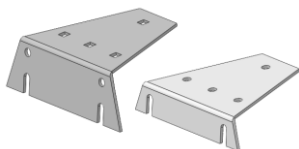

Sapata Dupla FC
99.00.652



Sapata Lisa
10.00.466



Sapata do Teto Tubular Reta
10.00.467

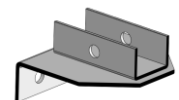

Sapata do Teto (tubular)
99.00.465



Bandô RF
15.00.003



Bandô FC
99.00.273



Bandô RD
99.00.064



Bandô
15.00.006



Travessa do Teto Tubular
2.410 - 99.00.296
2.720 - 99.00.297



Travessa do Teto Tubular
Ponta achatada
2.410 mm - 10.00.074
2.720 mm - 10.00.075

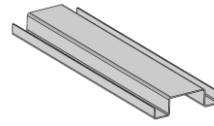

Cartola do Teto
2.410 mm - 99.00.481
2.720 mm - 99.00.482

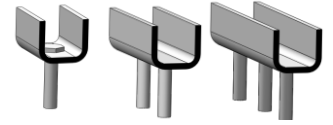

Suporte de Fixação
1 Parafuso - 99.00.328
2 Parafusos - 99.00.469
3 Parafusos - 99.00.660

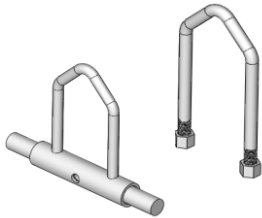

Sup. do Rodízio
c/ Eixo - 10.00.036
c/ Rosca - 99.00.276



Base de fix. da col. movél FC
99.00.905

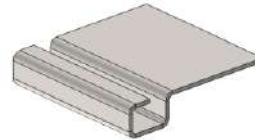

Pé de pato FC
10.00.041

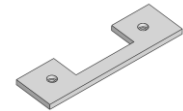

Base de Nylon do Pé de Pato
99.00.700

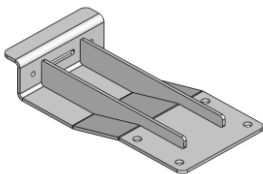

Pé de Pato c/ Rodízio T
60.00.005

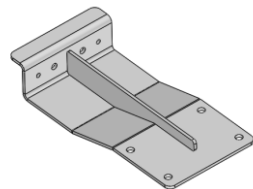

Pé de Pato
99.00.477



Roldana Cônica
99.00.269



Rodízio 1 Furo
1 Furo - 99.00.031
2 Furos - 99.00.314



Rodízio Duplo
99.00.425



Sup. de Fixação Plas.
99.00.303



Rodízio p/ Trilho de Ferro
17.00.010



Rodízio da Lona
40 mm - 99.00.665
35 mm - 99.00.089

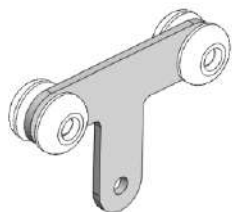

Rodizio Duplo em T
99.00.528



Guia do Varão FC
99.00.783

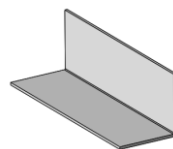

Trava Carga
99.00.664



Travessa de Contenção
20.00.012



Castan. Inf. da Col. Movél RD
99.00.694



Castanha Inf. Col. Movél
99.00.574

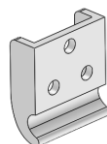

Trava Inf.Coluna Movél
99.00.573

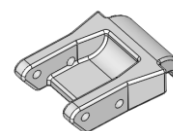

Trava Inf. da Coluna Movél
99.00.693

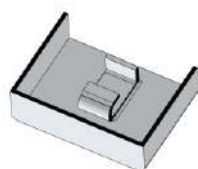

Sup. Base Coluna Movél
99.00.181



Cavalete do Sider
99.00.326



Cont. de Port. do Sider RD
99.00.750



Trava pallet do sider
50.00.055



Cont. de Port. do Sider CV
99.00.615



Lona Lateral para sider
22.00.001



Lona para sider
Amarela - 99.00.081
Vermelha - 22.00.003
Azul - 22.00.004
Verde - 22.00.005
Prata - 22.00.006
Preta - 22.00.007
Branca - 22.00.008
Cinza - 22.00.009



Lona do teto do sider
22.00.002

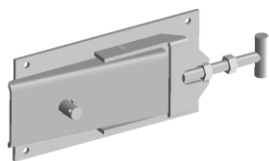

Trinco Easy do Sider de Bebidas
10.00.073

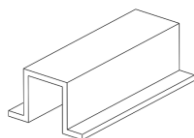

Guia do sider asa delta
72.00.021



Pistão do sider asa delta
875 mm - 99.00.411
1.000 mm - 99.00.701



Reparo do Pistão da asa delta
32 mm - 99.00.832
50 mm - 99.00.833



Rodizio do Sider de Bebidas
17.00.001

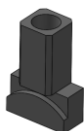

Guia do Rodízio do Sider de Bebidas
17.00.005



Suporte e Argola da Cortina
60.00.010



Guia Jota
78.00.435

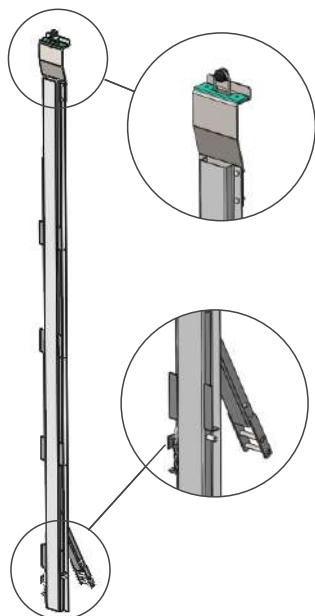

Coluna Movél RD Antiga
99.00.492

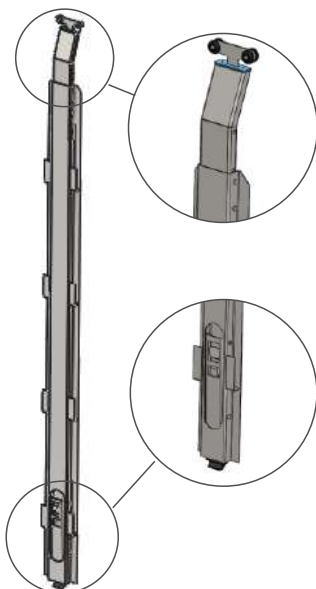

Coluna Movél RD Nova
40.07.003

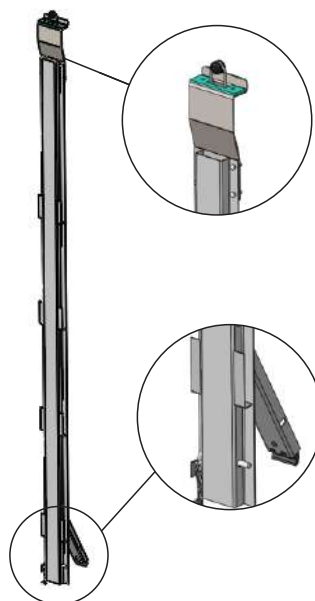

Coluna Movél RF
99.00.705

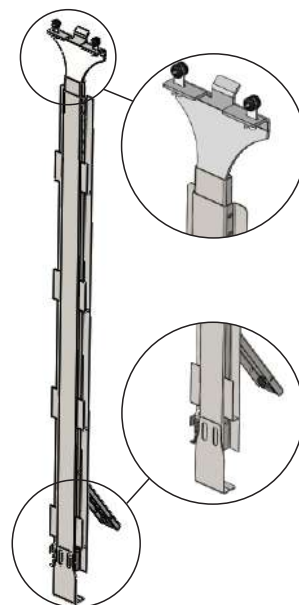

Coluna Movél FC
40.04.001



COLUNA MOVÉL

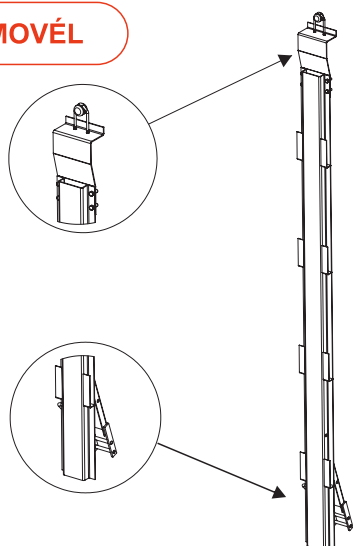

TETO

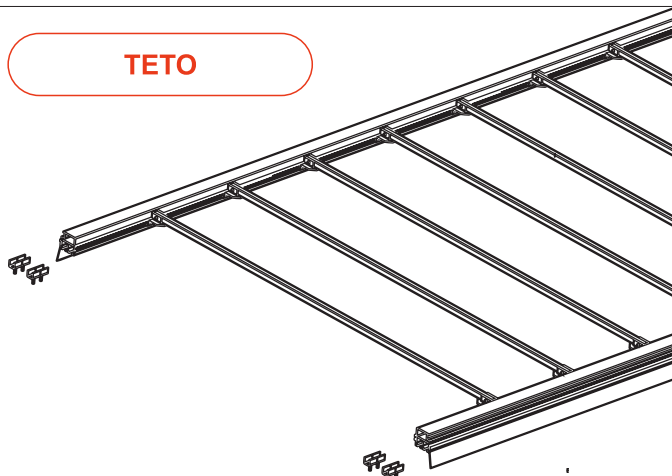

PAINEL FRONTAL

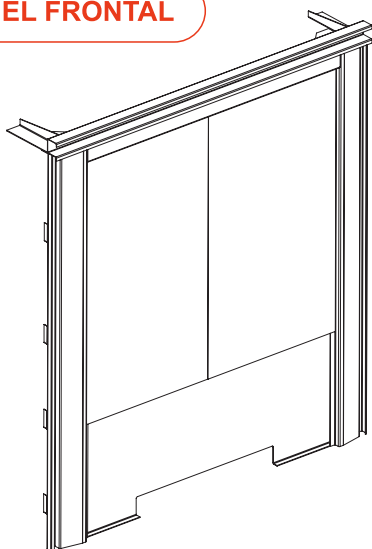

PAINEL TRASEIRO

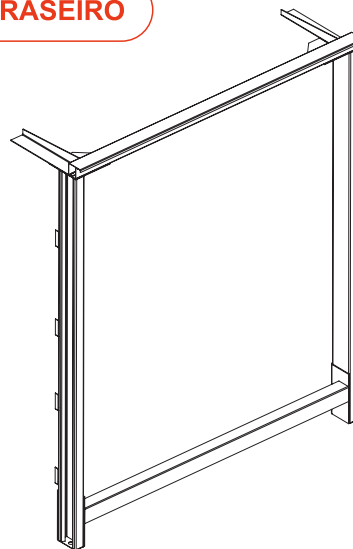



DOBRE EIXO[®]
PEÇAS PARA BAÚS E SIDER

Lealdade em Negócios

PEÇAS PARA BASES



WWW.DOBREEIXO.COM.BR

(11) 2087 - 5322

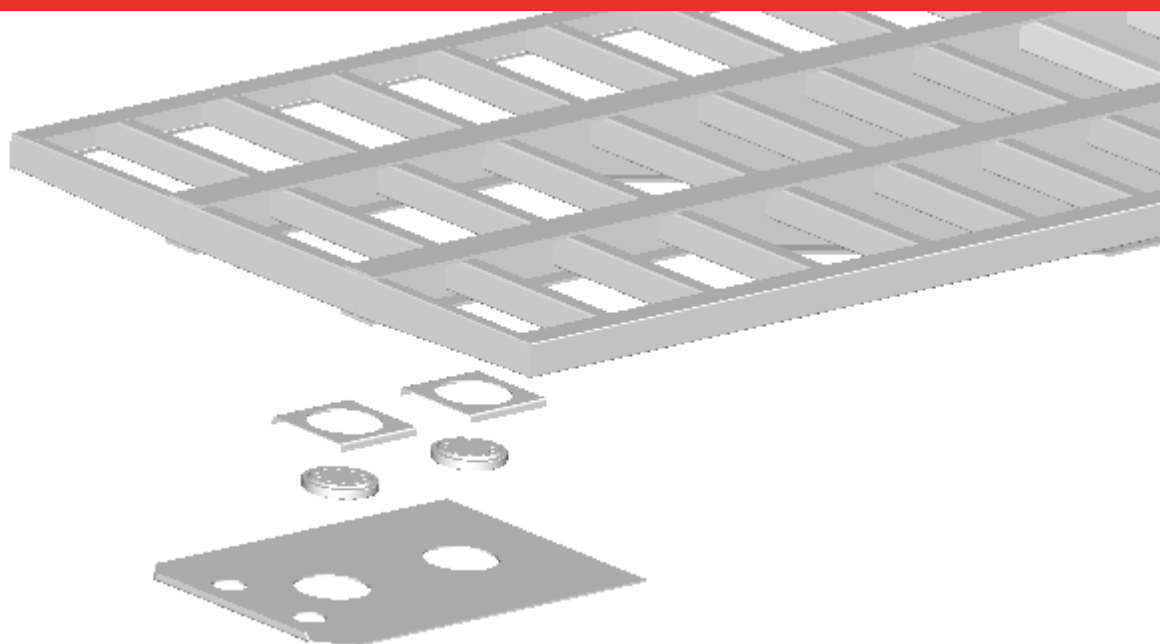

**TEMOS MAQUINA DE CORTE A PLASMA CNC
PARA FAZER FUROS E CORTES COMPLEXOS EM CHAPAS**

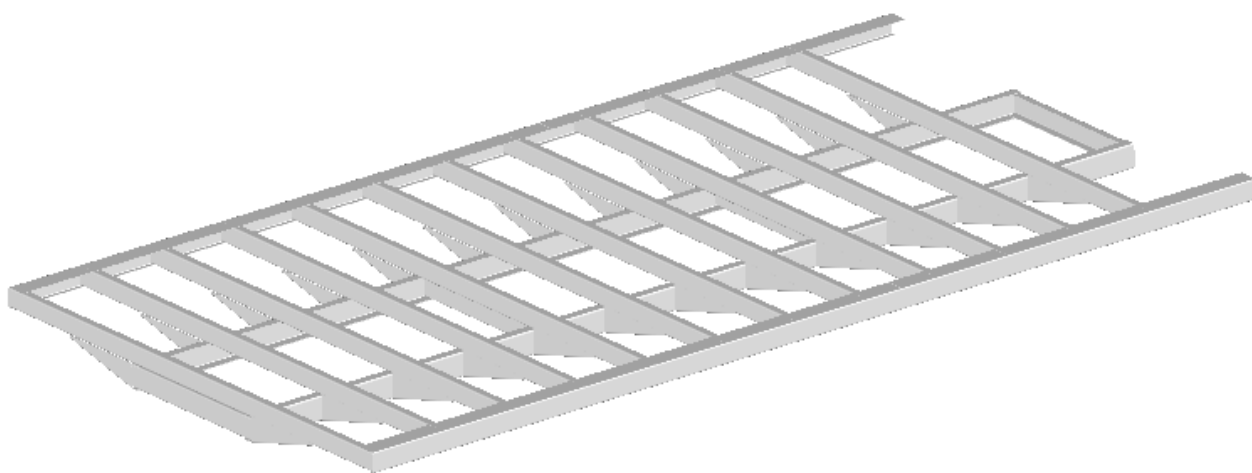

CORTE E DOBRA DE PEÇAS PARA CHASSIS



DOBRE EIXO[®]
PEÇAS PARA BAÚS E SIDER

Lealdade em Negócios

PEÇAS PARA CARROCERIAS

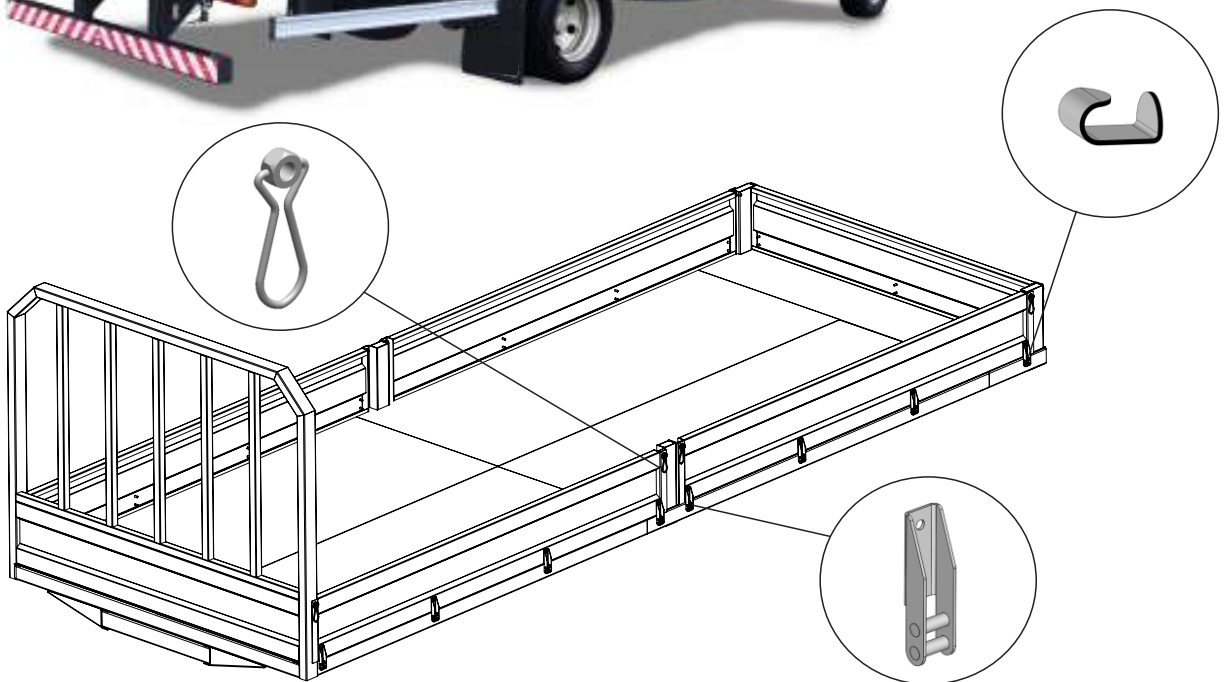

WWW.DOBREEIXO.COM.BR

(11) 2087 - 5322

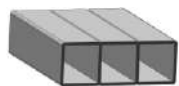

Tira Fina Tubular
99.00.052

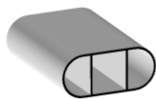

Tira Fina Tubular Aredo.
12.00.009



Tampa Plastica
99.00.091

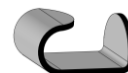

Engate G - GRD
99.00.274



Engate G PEQ
99.00.513



Dobradiça Carga Seca - PEQ
99.00.512



Dobradiça Carga Seca - GRD
99.00.105

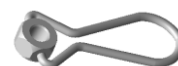

Porca de Canto 5/8
99.00.515



Porca de Canto 3/4
99.00.802

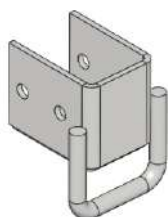

Sup. de Amarr. de Carga
21.00.018



Sup. de Amarr. de Carga
44.00.007



Meia Argola
99.00.708



Fixador da Meia Argola
99.00.709



Gancho Garra
3/8 - 99.00.630
5/16 - 99.00.632

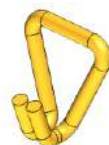

Gancho J
99.00.707



Gancho quadrado
10.00.468



Catraca Móvel
99.00.087



Rabicho da catraca móvel
com gancho J
18.00.003



Cinta de Amarr. 50 x 9MT
1,5 Ton. - 99.00.088



Cinta de Amarr. 50 x 9MT
3 Ton. - 99.00.505



Cinta de Amarr. 50 x 9MT
1,5 Ton - 99.00.853



Cinta de Amarr. 50 x 9MT
3 Ton. - 99.00.854



Cinta de Amarração 100x9MT
10 Ton. - 18.00.011



Rabicho da Fivela
99.00.205



Rabicho da catraca móvel
com gancho G
18.00.002



Catraca Esp. P/ Cabo de Aço
99.00.305



Catraca Fixa 100 mm
10.00.089



FABRICAMOS POR
ENCOMENDA TODOS
OS TAMANHOS DE
CINTAS E RABICHOS

Temos homologação para
Suporte de Amarração de Carga



Coluna Protetor Curvo
Estreita - 99.00.119
Larga - 10.00.077



Coluna Protetor Reto
99.00.120



Travessa Lateral
99.00.154



Travessa Lateral
99.00.614



Travessa de Contenção
20.00.012



Travessa Lateral AG
99.00.337

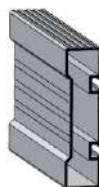

Travessa Lat. FC Alum.
50.04.040

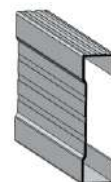

Trave. Lat. Dobre Eixo Alum.
50.15.001



Acabamento do Protetor RD
99.00.816



Acabamento do Protetor
99.00.215



Coluna Dupla
99.00.208



Coluna Simples
99.00.288



Sup. do Prot. Lat. Móvel
99.00.899



Sup. do Prot. Lat. Fixo
99.00.860

Protetor de ciclista

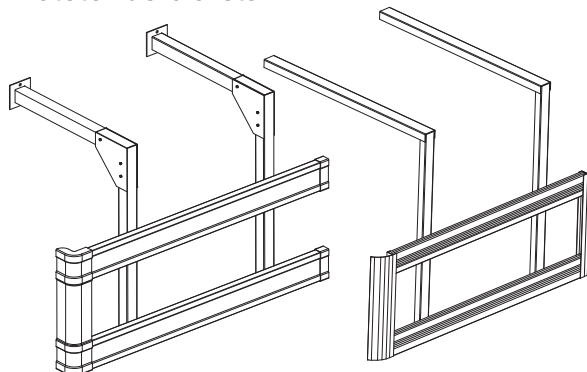

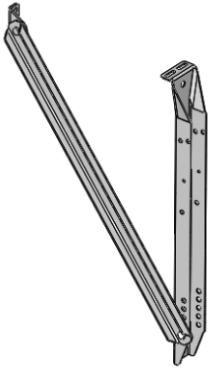

Sup. do Prot. Lat. RD
21.00.025

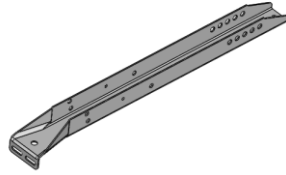

Coluna do Prot. lat RD
21.00.026

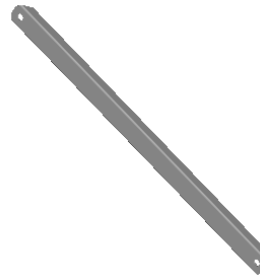

Mão Francesa do
Suporte do Prot. lat RD
21.00.027



Suporte de Fixação do
Suporte do Prot. lat RD
D - 21.00.028
E - 21.00.031

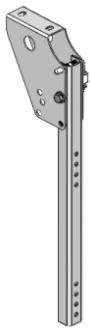

Sup. do Prot. de ciclista FC
64.04.001

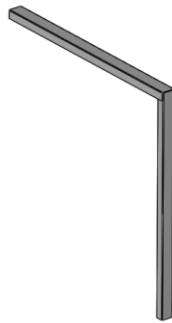

Suporte do Protetor simples
99.00.912



Aceitamos todos os cartões



Aceitamos cartão



Aceitamos todos os cartões



Aceitamos cartão



Aceitamos todos os cartões



Aceitamos cartão



Aceitamos todos os cartões



Aceitamos cartão





Batente
99.00.427

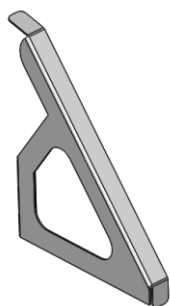

Levanta Fio TV
D - 74.08.001
E - 74.08.002

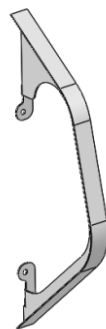

Levanta Fio RD
D - 44.07.001
E - 44.07.002

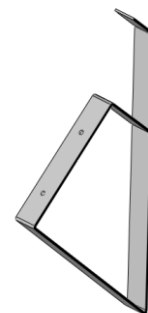

Levanta Fio
99.00.078

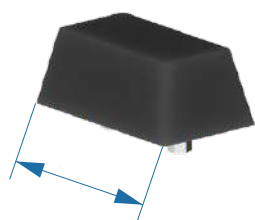

Batente Retangular
250 mm - 78.00.570
300 mm - 78.00.569



Batente de borracha Lat.
99.00.603



Abraçadeira
5/8 - 99.00.143



Abraçadeira
1/2 - 99.00.138



Vergalhão
1/2 - 99.00.285
5/8 - 99.00.286



Ripa de Alumínio
99.00.677



Ripa Galv. Dobreeixo
99.00.661

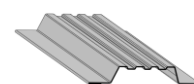

Ripa Galvanizada
20.00.011



Fixação do Pé Mecânico
99.00.292







Assoalho Naval
99.00.626 - Largo 2500 x 1M
99.00.264 - 2500x1600x16 mm
99.00.421 - 2500x1600x18 mm
99.00.214 - 2500x1600x20 mm

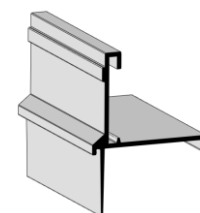

Ripa de Madeira 70x20
99.00.062

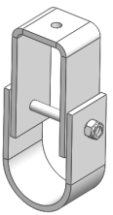
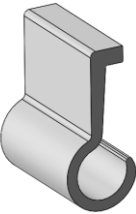
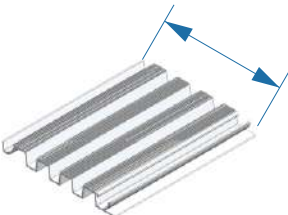
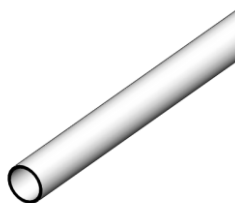

Contorno de porta WR
99.00.095

 <p>Varão Trava Pallet 99.00.567</p>	 <p>Varão Trava Pallet RD 10.00.105</p>	 <p>Varão Trava Pallet Logístico 10.00.106</p>	 <p>Varão Trava Pallet c/ Sapata 99.00.845</p>
 <p>Trilho Logístico Gal - 99.00.447 Alum - 78.00.405</p>	 <p>Cartola Trava Pallet 99.00.520</p>	 <p>Cabideiro Vertical 99.00.170</p>	 <p>Cabideiro Múltiplo 20.00.030</p>
 <p>Varão Cabideiro 99.00.712</p>	 <p>Bin Socket 99.00.716</p>	 <p>Gancho TPE 99.00.491</p>	 <p>Chapa Xadrez de Alumínio 2.500 mm x 1.000 mm 2,2 - 99.00.042 2,7 - 99.00.431</p>
 <p>Gancheira Frigorífica 99.00.710</p>	 <p>Gancheira Frigo. de alum. 12.00.005</p>	 <p>Piso Frigorífico 240 mm - 99.00.194 275 mm - 50.00.049</p>	 <p>Tubo da Gancheira 48 mm 99.00.889</p>



Cantoneiras
20x20 - 50.00.001
25x25 - 50.00.002
30x30 - 50.00.003
50x50 - 50.00.004
60x90 - 99.00.397
100x150 - 99.00.376



Cantoneira de PVC 50x50
99.00.209



Came
D - 11.00.001
E - 10.00.002



Ligueta
D - 11.00.005
E - 11.00.006



Guia do Came
10.00.025



Manete Maior
99.00.098

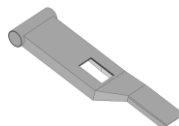

Manete Menor
10.00.028



Bandeja
G - 99.00.099
P - 10.00.026



Trava da Alavanca
99.00.129



Manete
99.00.271



Alavanca
99.00.372



Alavanca
99.00.039



Tramela
99.00.118



Guia do Came RF
GRD - 99.00.571
PEQ - 99.00.570



Alavanca GRD. e PEQ.
G - 10.00.001
P - 10.00.006



Suporte da Alavanca
G - 10.00.002
P - 10.00.007



Trinco Bag. c/chave Branco
99.00.248



Bandeja Anti-Panico
99.00.247



Bandeja c/Trinco sem Chave
99.00.216



Bandeja cinza c/ trinco e com chave ou sem chave
C - 99.00.245
S - 99.00.246



Bandeja de Alu. C/ Gat. Map.
99.00.191



Bandeja FC S/ Prisioneiros
17.04.006



Trinco de Plas. FC (Refri.)
99.00.340



Bandeja de Nylon Menor
99.00.752



Bandeja FC C/ Prisioneiros
99.00.332

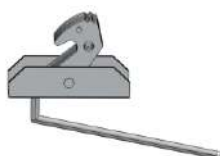

Bico de Papagaio c/ Alav.
10.00.031



Bico de Papagaio
10.00.030



Contra Pino
1/8X1" - 99.00.257
1/8X1.1/2 - 99.00.256

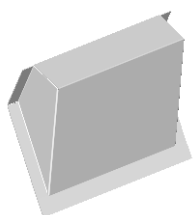

Aleta Galvzanizada
71.07.019



Entrada de Ar Lisa
99.00.151



Entrada de Ar Frisada
99.00.680

Aceitamos cartão





Borracha RC Simples
99.00.345



Borracha RC Dupla
99.00.347



Borracha FC Porta INJ.
99.00.348

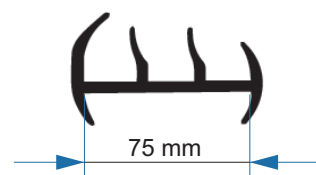

Borracha RD Frigorifica
99.00.133



Borracha IC (JOTA)
99.00.435

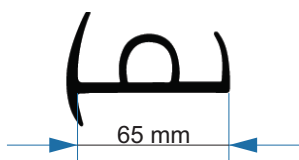

Borracha RC 65 mm
99.00.284



Borracha IB Frigorifica
99.00.139



Borracha CBB
99.00.085



Borracha 25 x 19
99.00.008



Borracha 40 x 20
99.00.009



Borracha Multiuso
99.00.354

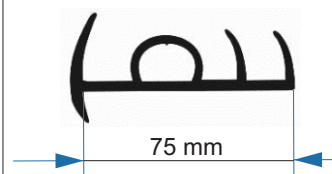

Borracha RC 75 mm
99.00.353



Borracha CV
99.00.007



Borracha FC Porta Batente
99.00.147



Borracha RD Sem Aba
99.00.058

Aceitamos todos os cartões



Piso Roletado

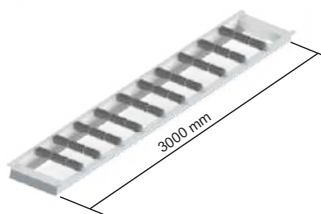

Rolete
PEQ - 99.00.835
GRD - 99.00.836



Eixo 5/8
10.00.034



Suporte do Botijão
44.00.015

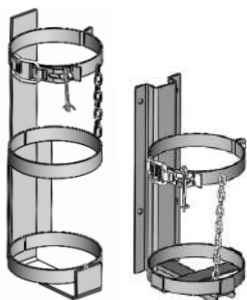

Suporte do Extintor 12 kg
8 kg - 44.00.019
12 kg - 44.00.005



Suporte do Cone
44.00.016



Porta Documento
44.00.004



Sup. do Cone Redondo
44.00.017

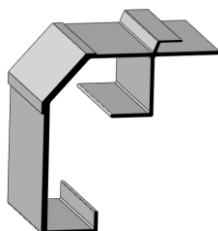

Coluna FG
99.00.644



Escada Retratil RF
44.00.018



Escada Retratil
99.00.189



Dobradiça Kombi
99.00.449



Caixa de ferramentas de Plastico
PEQ - L 420 X A 290 X P 340 - 99.00.842
MED - L 420 X A 290 X P 360 - 99.00.843
GRD - L 600 X A 500 X P 460 - 99.00.844

Aceitamos todos os cartões



Aceitamos todos os cartões



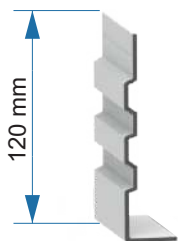

Saia 120 Ibiporam Antiga
50.10.001

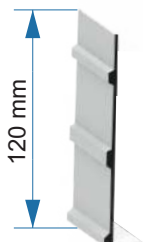

Saia 120 Ibiporam Nova
99.00.392

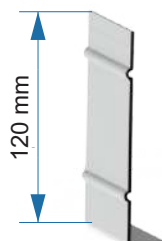

Saia 120 Ibipo. Friso Red.
99.00.530

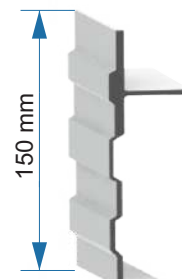

Saia Recrosul 150
50.11.001

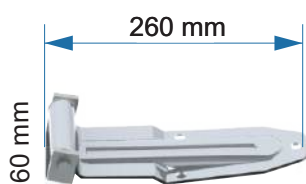

Cj. Dobradiça Furgão
220 mm Cod - 99.00.569
265 mm Cod - 99.00.404
290 mm Cod - 16.00.003

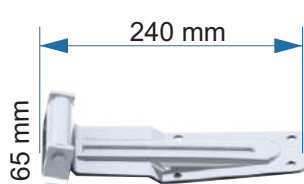

Cj. Dobradiça Inox
240 mm Cod - 99.00.818
270 mm Cod - 99.00.418
300 mm Cod - 16.00.006

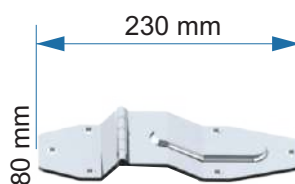

Dobradiça Inox lateral
99.00.533

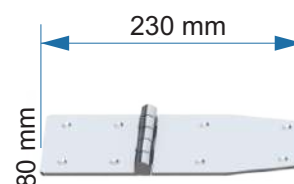

Dobradiça Inox Plana
99.00.405



Dobradiça inox Lateral
99.00.646



CJ. dobradiça Inox traseira
16.00.004

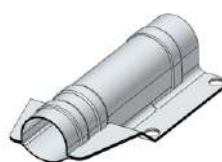

Conjunto Mancal Extrem
1" - 99.00.557
3/4 - 99.00.558



Mancal Inox Interme. 1"
99.00.410



Mancal Inox cj.
1" - 99.00.407
3/4 - 99.00.408





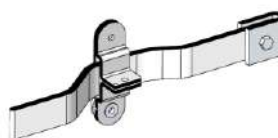







Bandeja Trinco Inox
99.00.406

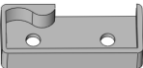

Cj Alavanca Inox
99.00.203



Trava da Alavanca Inox
99.00.204

 <p>Trinco externo inox s/ chave 1" - 16.00.025</p>	 <p>Trinco Inox Externo com Chave e Com Tampa 1" - 99.00.131 3/4 - 99.00.508</p>	 <p>Bandeja c/ Chave c/ Tampa 99.00.496</p>	 <p>Trinco do bagageiro inox com chave e sem chave C - 16.00.018 S - 16.00.016</p>
 <p>Trinco Externo Inox 1" - 99.00.413 3/4 - 99.00.509</p>	 <p>Caixa do Came D - 99.00.399 E - 99.00.414</p>	 <p>Came Vazado 99.00.398</p>	 <p>Lingueta Inox 1" - 99.00.400 3/4 - 99.00.402</p>
 <p>Trava Porta femea Inox 99.00.412</p>	 <p>Trava Porta Macho 90 mm - 99.00.562 120 mm - 99.00.416</p>	 <p>Varão Inox 1" - 99.00.329 3/4 - 99.00.330</p>	 <p>Engate da Lingueta 1" - 99.00.401 3/4 - 99.00.403</p>
 <p>Tampa de Fechamento 17.00.002</p>	 <p>Faixa Refletiva 99.00.137</p>	 <p>Escada p/ Baú frigorífico 44.00.012</p>	<p>Aceitamos cartão</p> 

REBITE MACIÇO (Lentilha)

Rebite Maciço 1/4 X 1/2 - 99.00.022
 Rebite Maciço 1/4 X 5/8 - 99.00.148
 Rebite Maciço 3/16 X 1/2 - 13.00.002
 Rebite Maciço 3/16 X 3/4 - 99.00.149
 Rebite Maciço 3/16 X 3/8 - 99.00.036
 Rebite Maciço 3/16 X 5/8 - 99.00.110
 Rebite Maciço 3/16 X 7/16 - 99.00.458



REBITE POP 1/4"

Rebite Pop 3/16 x 1/2 - 13.00.007
 Rebite Pop 3/16 x 5/8 - 99.00.381
 Rebite Pop 3/16 x 3/4 - 99.00.140
 Rebite Pop 3/16 x 7/8 - 99.00.576
 Rebite Pop 3/16 x 1 - 99.00.578
 Rebite Pop 3/16 x 1.1/4 - 99.00.577
 Rebite Pop 3/16 x 1.3/8 - 99.00.067
 Rebite Pop 1/4 x 1/2 - 99.00.393
 Rebite Pop 1/4 x 5/8 - 99.00.438
 Rebite Pop 1/4 x 3/4 - 99.00.391
 Rebite Pop 1/4 x 1.3/8 - 99.00.217



REBITE COM ROSCA INVERTIDA

Rebite C/ Rosca Interna M6 - 13.00.053
 Rebite C/ Rosca Interna M8 - 13.00.054
 Rebite C/ Rosca Interna M10 - 13.00.055



GRAMPO PARA BAÚS

Grampo 340 x 90 x 5/8 - 99.00.684
 Grampo 360 x 90 x 5/8 - 99.00.234
 Grampo 380 x 90 x 5/8 - 99.00.235
 Grampo 400 x 90 x 5/8 - 99.00.244
 Grampo 420 x 90 x 5/8 - 99.00.236
 Grampo 440 x 90 x 5/8 - 99.00.237
 Grampo 460 x 90 x 5/8 - 99.00.238
 Grampo 480 x 90 x 5/8 - 99.00.239
 Grampo 500 x 90 x 5/8 - 99.00.240
 Grampo 520 x 90 x 5/8 - 99.00.241
 Grampo 540 x 90 x 5/8 - 10.00.058
 Grampo 320 x 80 x 5/8 - 10.00.059



CHAPA DE GRAMPO

Chapa de Grampo 1/2 - 99.00.200
 Chapa de Grampo 3/8 - 99.00.298



PARAFUSO SEXTAVADO

Parafuso sx 1/4 x 3/4 - 99.00.068
 Parafuso sx 5/16 x 1 - 99.00.177
 Parafuso sx 5/16 x 1.1/2 - 99.00.534
 Parafuso sx 3/8 x 1 - 13.00.038



PORCAS

Porca sx 1/4 - 99.00.601
 Porca sx 1/4 Travante - 99.00.069
 Porca sx 3/8 Travante - 99.00.595
 Porca sx 1/2 Travante - 99.00.594
 Porca sx 5/6 Travante - 99.00.178
 Porca sx M6 - 13.00.389
 Porca sx 5/8 - 99.00.242 Porca p/ Grampo



PORCA

Porca de Canto 5/8 - 99.00.515
 Porca de Canto 3/4 - 99.00.802



PARAFUSOS FRANCÊS

Parafuso Francês - 1/4 1.1/2 - 99.00.485
 Parafuso Francês - 1/4 1.1/14 - 99.00.438
 Parafuso Francês - 3/8 1.1 1/2 - 99.00.532
 Parafuso Francês - 5/16 1.1/2 - 99.00.749



CONTRA PINO

Contra Pino - 1/8X1" - 99.00.257
 Contra Pino - 3/16X2" - 13.00.003
 Contra Pino - 1/8X1.1/2 - 99.00.256
 Contra Pino - 1/8 2 1/2 - 99.00.745
 Contra Pino - 2,5"X20 - 13.00.004



PINO ELÁSTICO

Pino Elástico 5x26 - 99.00.219
 Pino Elástico 5X32 - 99.00.254
 Pino Elástico 6x26 - 99.00.171
 Pino Elástico 6x32 - 99.00.255



PARAFUSOS BROCANTE

Parafuso Brocante 3/16 x 1.1/2 - 99.00.518
 Parafuso Brocante 3/16 x 3/4 - 99.00.618



ARRUELA LISA

Arruela Lisa - 1/4 - 99.00.070
 Arruela Lisa - 5/16 - 13.00.179
 Arruela Lisa - 3/8 - 99.00.40

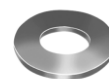



Lanterna 110 GF
Cristal - 99.00.541
Amarela - 99.00.540
Vermelha - 99.00.542



Lanterna GF 212 Topo
Cristal: 99.00.290
Vermelha: 99.00.201
Amarela: 99.00.674



Lanterna 206 GF
Cristal: 99.00.452



Lanterna GF 214
Cristal: 99.00.539
Amarela: 99.00.537
Vermelha: 99.00.538



Lanterna GF 121
Amarela - 99.00.691



Lanterna GF 115
Cristal - 99.00.672
Amarela - 99.00.673
Vermelha - 99.00.670



Lanterna AF 393 RD Topo
Cristal - 99.00.906
Vermelha - 99.00.907



Lâmpada 1034
12V - 99.00.546
24V - 99.00.547



Lâmpada 69
12V - 99.00.202
24V - 99.00.507



Lâmpada 67
12V - 99.00.675
24V - 99.00.545



Lâmpadada 1141
12V - 99.00.548
24V - 99.00.584



Selante Cinza
99.00.063



Selante PU
99.00.134



Selante Branco
99.00.476



Massa de Calafeta Balde 25 KG
99.00.086



Fita Dupla Face
15.00.061



Fita Esponjosa
99.00.034



Amortecedor 435 mm
99.00.527



Rebitador Manual
99.00.152



Mola do Marteleto
99.00.025



Marteleto / Ponteira
M - 99.00.580
P - 99.00.561



Aplicador de Silicone
99.00.153



Riscador de Chapa
99.00.688



Rebitadeira Manual
M3 a M10 compacta
29.00.001



Janela com Borracha
500x300 Cod: 99.00.500
520x320 Cod: 99.00.583
600x400 Cod: 99.00.479
600x600 Cod: 99.00.501
700x400 Cod: 99.00.352
700x500 Cod: 99.00.504



Trava Lock
99.00.478



CJ. Pe Mecânico
99.00.160



Manivela Pé Mecânico
99.00.587

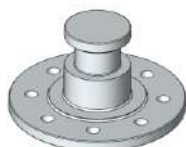

Pino Rei
210 mm - 99.00.599
160 mm - 10.00.091



Eixo de Lig. do Pé Mecân.
99.00.210



Caixa de ferramentas C/ Cadeado
L= 1.000 A= 530 P= 570 mm Cod: 99.00.560
L= 1.450 A= 600 P= 450 mm Cod: 99.00.563
L= 1.850 A= 600 P= 450 mm Cod: 99.00.524
L= 2.150 A= 450 P= 600 mm Cod: 99.00.564
L= 2.300 A= 600 P= 450 mm Cod: 99.00.565
L= 460 A= 275 P= 370 mm Cod: 99.00.498

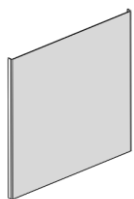

Paralama Reto
500 x 500 mm - 21.00.039
600 x 600 mm - 21.00.038



Base do Suporte de Nylon
99.00.453



Tubo do Sup. do Paralama
10.00.040



Suporte do Paralama
99.00.764

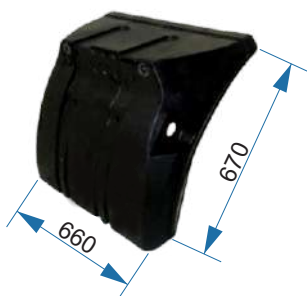

Meio Paralama RD
D - 17.07.002
E - 17.07.001



Paral. FC para carreta 2009
D - 99.00.341
E - 99.00.342



Paralama RD Envolvente
99.00.806



Meio Paralama FC
D - 99.00.769
E - 99.00.770



Paralama FC Leve 2010
D - 99.00.335
E - 99.00.336



Meio para-lama fc
tras s. chassi SL 2010
74.04.006



Meio para-lama fc
tras s. chassi SP 2010
74.04.007



Para-lama fc leve (HR)
99.00.551

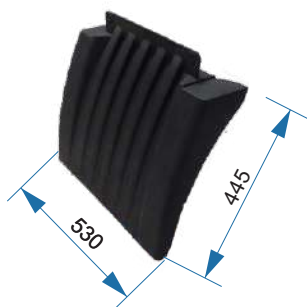

Meio para-lama fc
Dianteiro SL 2010
17.04.003



Meio Paralama FC 2010
D - 99.00.884
E - 99.00.885



Parabarro
2.600 x 700 - 99.00.389
700 x 600 - 99.00.387
700 x 500 - 99.00.386
600 x 500 - 99.00.385
500 x 500 - 99.00.384
400 x 500 - 99.00.383

Aceitamos cartão



FABRICAMOS PORTAS PARA BAÚS DE DIVERSOS MODELOS

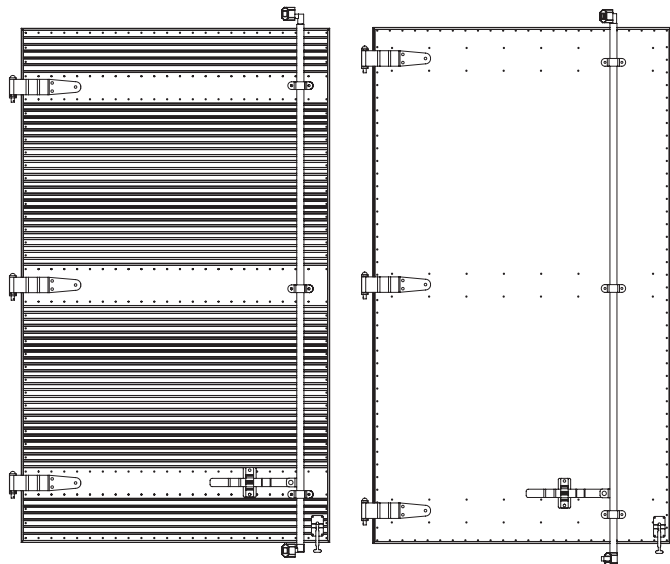

Contorno de Porta 40 mm
99.00.182



Dobradiça
10.014.002

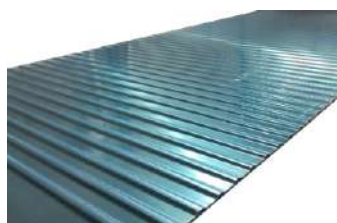

Chapa de Alumínio
99.20.001



Varão
32 mm - 99.00.006
25 mm - 99.00.015



Trava alav. GRD e PEQ
G - 10.00.004
P - 10.00.010



Cavalete
10.04.012



Pino da Dobradiça
95 mm - 10.00.020
90 mm - 10.00.019



Cartola de Porta FC
20.00.009



Mancal Base
1" - 10.00.014
3/4 - 10.00.012



Mancal
1" - 10.00.013
3/4 - 10.00.011

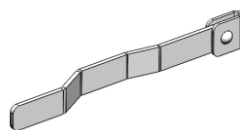

Cj Alavanca GRD e PEQ
G - 61.00.006
P - 61.00.005

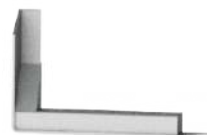

Batente Traseiro
D - 99.00.692
E - 99.00.697



3,50 Á 6,50 TON

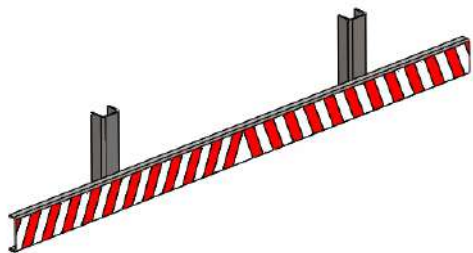

Para-choque HR
21.00.040

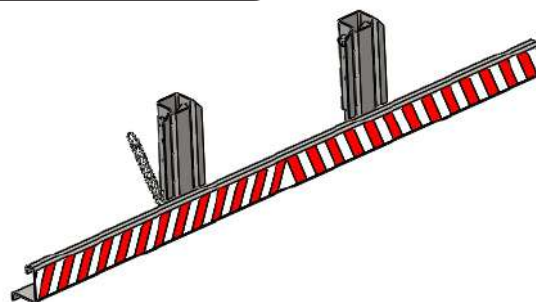

Para-choque Serie leve
21.00.041

6,50 Á 10,00 TON

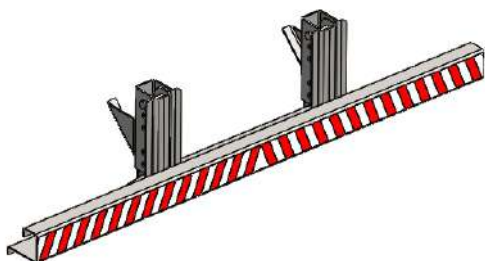

Para-choque
21.00.042

10,00 Á 23 TON



Para-choque
44.00.001

ACIMA DE 23 TON

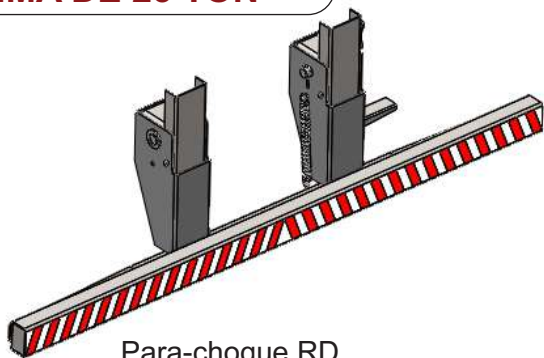

Para-choque RD
21.00.033

ACIMA DE 23 TON

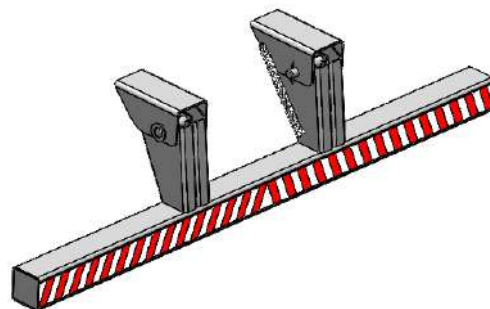

Para-choque FC
44.04.001



Mola do Parachoque
260 mm - 99.00.132
380 mm - 99.00.702
500 mm - 99.00.207



Faixa Refletiva
99.00.187

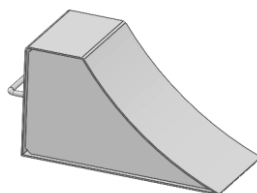

Calço de Roda
21.00.020

**TEMOS
PLACA DE
HOMOLOGAÇÃO
PARA
PARA-CHOQUE**



DOBRE EIXO[®]
PEÇAS PARA BAÚS E SIDER

Lealdade em Negócios

CARROCERIA DE BEBIDAS

Facchini e Rodofort



WWW.DOBREEIXO.COM.BR

(11) 2087 - 5322



Coluna Lateral Dupla
99.00.440



Coluna Simples
99.00.048

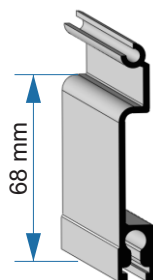

Perfil Inferior
99.00.123

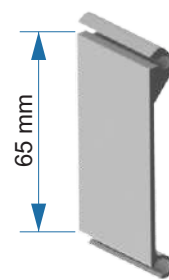

Perfil Superior
99.00.198

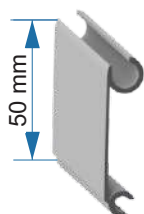

Perfil Intermediario
99.00.417

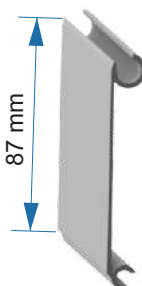

Perfil Intermediario
99.00.104

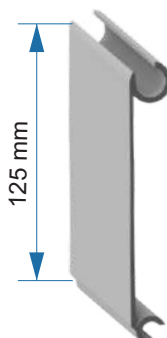

Perfil Intermediario
99.00.124

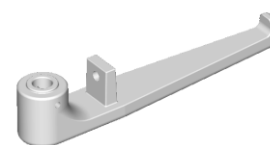

Trinco CBB FC
72.04.001



Mola 700 mm
99.00.306



Mancal Mola
Curto - 99.00.030
Longo - 99.00.032



Válvula Rotativa Manual
99.00.730



Rodizio Interme. 4 mm
17.07.003

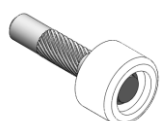

Rodizio Inferior 8 mm
17.07.004

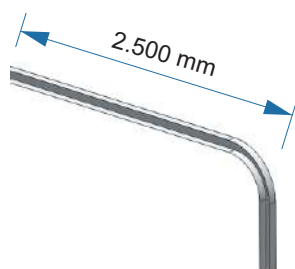

Trilho Curvado
D - 99.00.784
E - 99.00.785

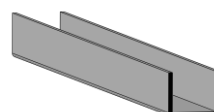

Trilho Reto
99.00.323



Curva do Trilho
99.00.484



Borracha Inferior
99.00.085



Track Line
2600 mm - 99.00.566



Borracha Superior CBB
99.00.525

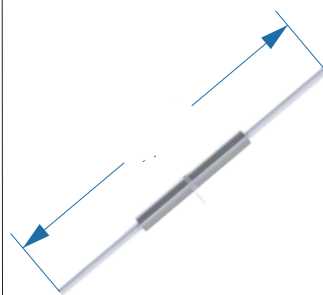

Balancin
725 mm - 99.00.800
1.720 mm - 99.00.112
1.340 mm - 99.00.128



Cabo de Aço
99.00.678



Pistão
99.00.711



Contra Pino
1/8X1 - 99.00.257
1/8X1.1/2 - 99.00.256



Mola do Varão
99.00.682



Varão de Ligação
1.276 mm - 99.00.503
1.676 mm - 99.00.502
2.065 mm - 99.00.544



Pino Base de acionamento
Menor - 99.00.717
Maior - 13.00.061

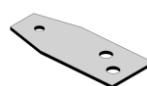

Base de Acionamento
99.00.719



Parafuso Allen NC 5/16 x 1/2
99.00.718



Suporte Superior do
Varão de ligação
72.00.004



Puxador
99.00.536



Cinta Dupla CBB
18.00.001

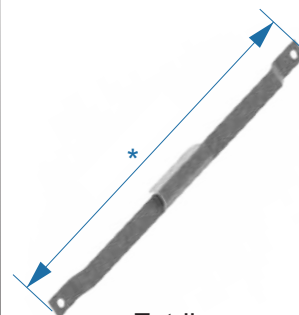

Estribo
1.400 mm - 99.00.127
2.750 mm - 10.00.042



Pega mão CBB
10.00.469



Suporte para Cone
21.00.021

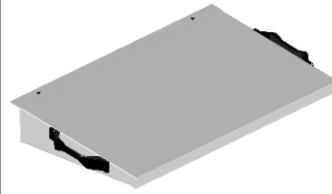

Plataforma Movél
21.00.019



Escova P/ CBB
99.00.197

Aceitamos cartão



Aceitamos cartão



Aceitamos Todos os Cartões

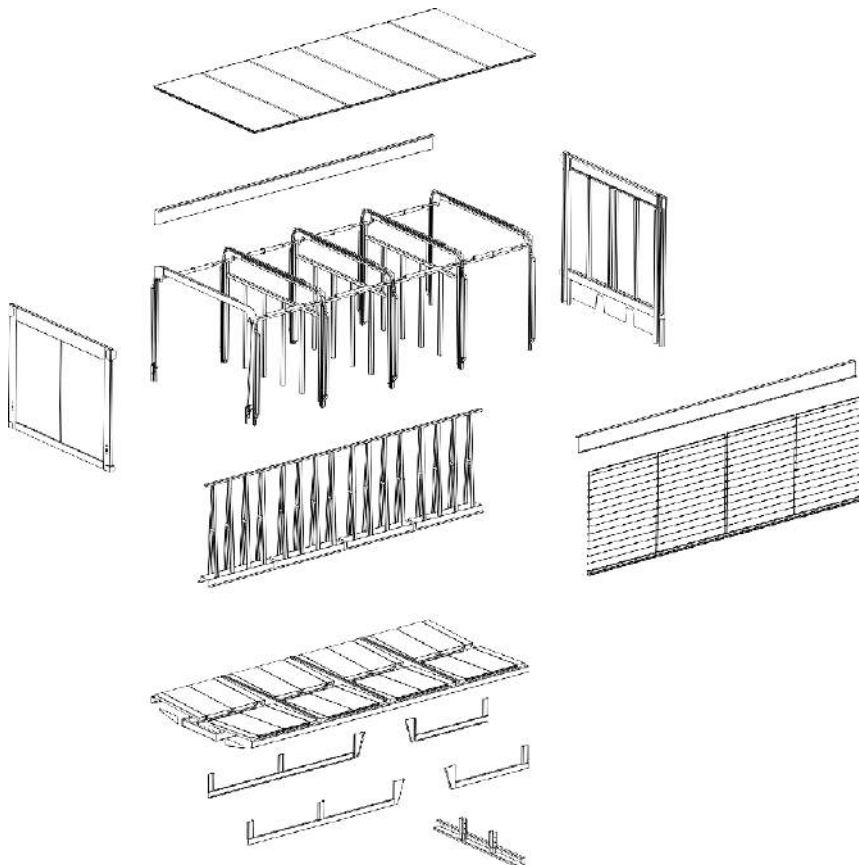

Aceitamos cartão



Aceitamos Todos os Cartões





DOBRE EIXO[®]
PEÇAS PARA BAÚS E SIDER

Lealdade em Negócios

CARROCERIA DE BEBIDAS



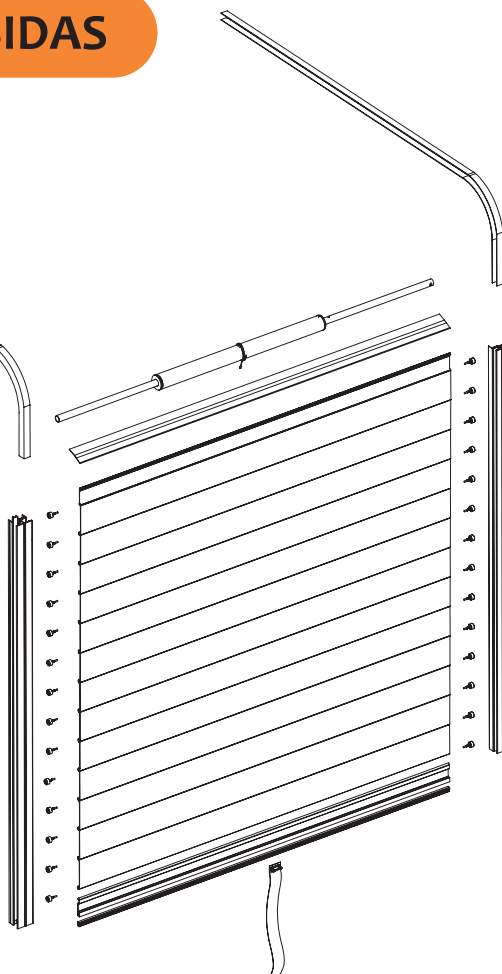









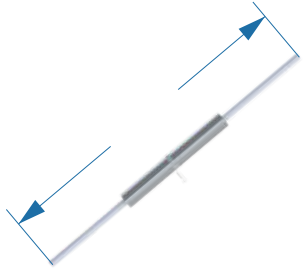
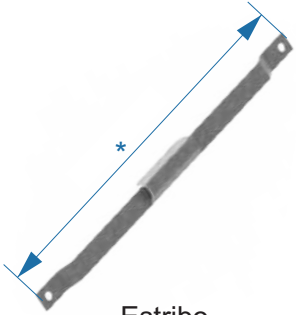

RANDON

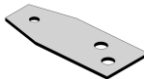

WWW.DOBREEIXO.COM.BR

(11) 2087 - 5322

 <p>Coluna Dupla 99.00.047</p>	 <p>Coluna Simples 99.00.048</p>	 <p>Coluna Simples Com Aba 99.00.307</p>	 <p>Perfil Inferior 99.00.123</p>
 <p>Perfil Superior 99.00.198</p>	 <p>Perfil Intermediario 99.00.417</p>	 <p>Perfil Intermediario 99.00.104</p>	 <p>Perfil Intermediario 99.00.124</p>
 <p>Trinco da Porta c/ ou S/ Chave S - 99.00.423 C - 99.00.035</p>	 <p>Mola 600 mm 99.00.647</p>	 <p>Mancal Curto da Mola 99.00.030</p>	 <p>Mancal Longo da Mola 99.00.032</p>
 <p>Rodizio Interme. 4 mm 17.07.003</p>	 <p>Rodizio Inferior 8 mm 17.07.004</p>	 <p>Trilho Curvado D - 99.00.784 E - 99.00.785</p>	 <p>Trilho Reto 99.00.323</p>

 <p>Curva do Trilho 99.00.484</p>	 <p>Borracha Inferior 99.00.085</p>	 <p>Track Line 2600 mm - 99.00.566</p>	 <p>Borracha Superior CBB 99.00.525</p>
 <p>Cabo de Aço 10.00.065</p>	 <p>Balancin 725 mm - 99.00.800 1.720 mm - 99.00.112 1.340 mm - 99.00.128</p>	 <p>Estribo 1.400 mm - 99.00.127 2.750 mm - 10.00.042</p>	 <p>Contra Pino 1/8X1. 99.00.257 1/8X1.1/2. 99.00.256</p>
 <p>Varão de Ligação 1.276 mm - 99.00.503 1.676 mm - 99.00.502 2.065 mm - 99.00.544</p>	 <p>Pino Base de acionamento Menor - 99.00.717 Maior - 13.00.061</p>	 <p>Base de Acionamento 99.00.719</p>	 <p>Parafuso Allen NC 5/16 x 1/2 99.00.718</p>
 <p>Cinta 99.00.536</p>	 <p>Cinta Dupla CBB 18.00.001</p>	 <p>Mola do Varão 99.00.682</p>	 <p>Suporte Superior do Varão de ligação 72.00.004</p>



Pega Mão CBB RD

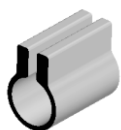

Abraçadeira do
Pega Mão CBB RD
12.07.001

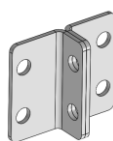

Fixador do
Pega Mão CBB RD
62.07.001



Suporte para Cone
21.00.021



Tubo de Alumínio do
Pega Mão CBB RD
72.07.001

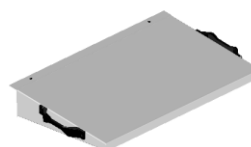

Plataforma Movél
21.00.019



Escova P/ CBB
99.00.197

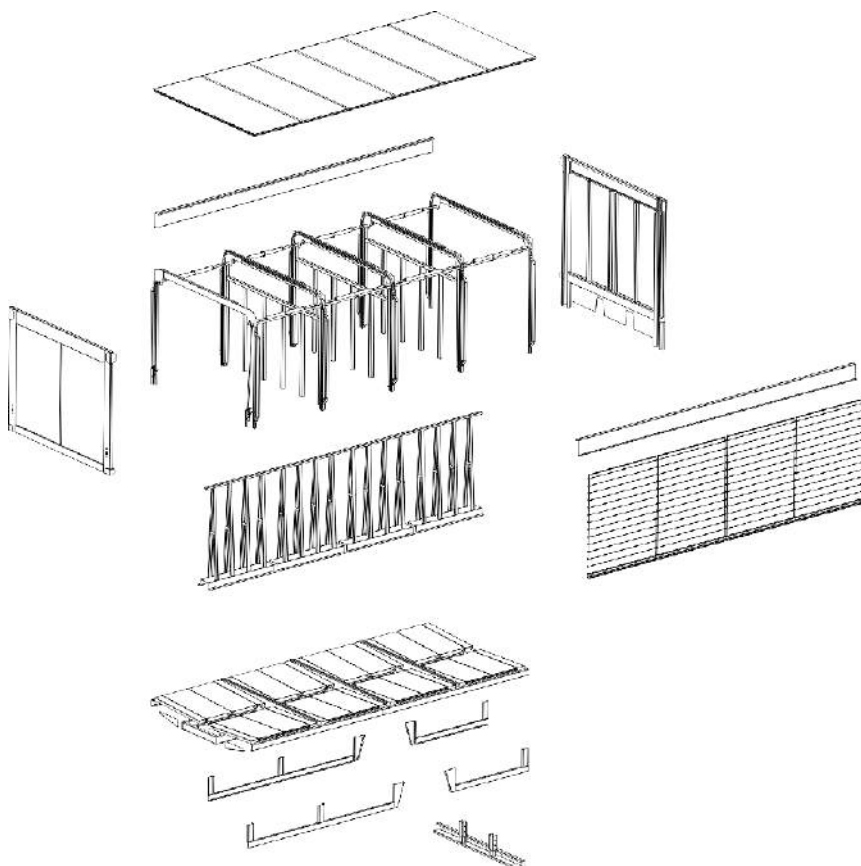

Aceitamos cartão



Aceitamos Todos os Cartões





DOBRE EIXO[®]
PEÇAS PARA BAÚS E SIDER

Lealdade em Negócios

PORTAS ROLL-UP



WWW.DOBREEIXO.COM.BR

Essa Sua Frota Merece



D.E.P.R.[®]

DOBRE EIXO PORTAS ROLL-UP

Lealdade em Negócios

PORTA ROLL-UP

100 % Alumínio



100 % Alumínio



WWW.DOBREEIXO.COM.BR

Essa Sua Frota Merece

100 % Alumínio

Porta Roll-up

Peças de Reposição

www.dobreeixo.com.br
(11) 2087-5322

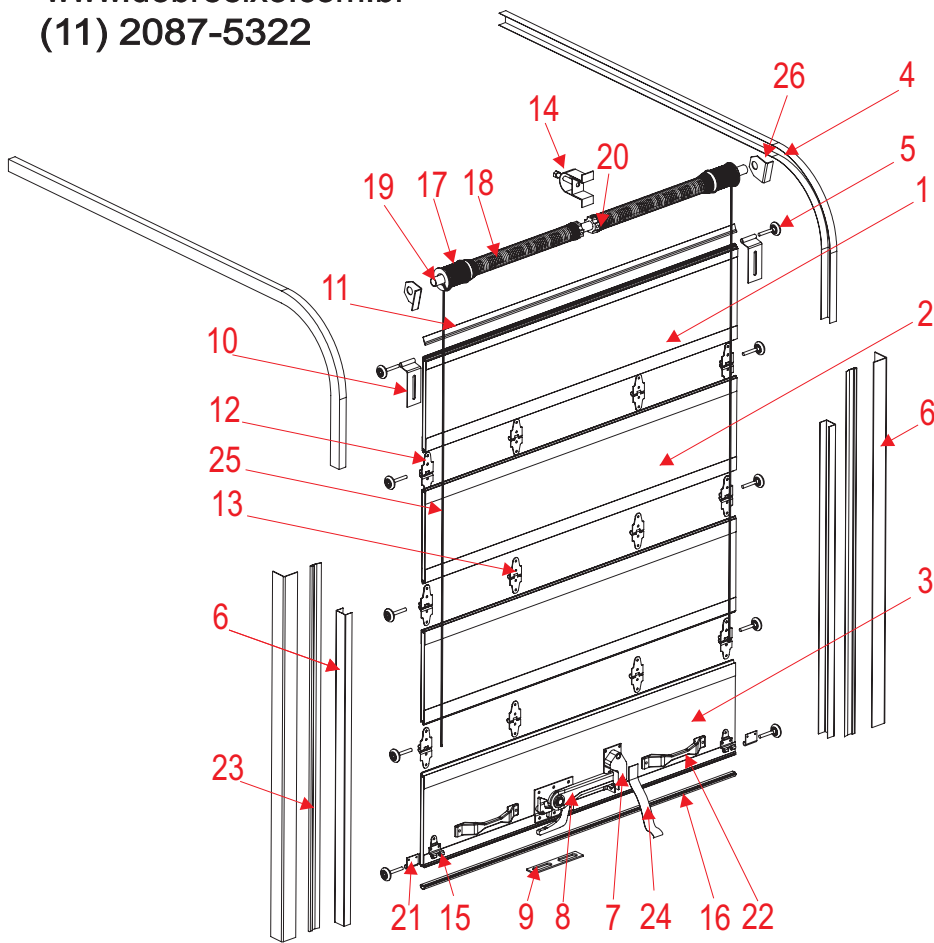

Descrição

- 1 PAINEL SUPERIOR
- 2 PAINEL INTERMEDIARIO 400 MM
- 3 PAINEL INFERIOR
- 4 TRILHO CURVADO
- 5 RODIZIO
- 6 C.J CANTONEIRA E TRILHO RETO
- 7 C.J. TRAVA TRINCO
- 8 TRINCO DA PORTA
- 9 OCULOS
- 10 SUPORTE REGULAVÉL
- 11 VEDAÇÃO SUPERIOR
- 12 C.J DA DOBRADIÇA LATERAL
- 13 DOBRADIÇA INTERMEDIARIA
- 14 SUPORTE CENTRAL DO BALANCIN
- 15 SUPORTE DO CABO DE AÇO
- 16 VEDAÇÃO INFERIOR
- 17 CARRETEL DO CABO DE AÇO
- 18 MOLA
- 19 VARÃO DA MOLA
- 20 CASTANHA DA MOLA
- 21 SUPORTE INFERIOR
- 22 PEGA MÃO
- 23 VEDAÇÃO LATERAL
- 24 PUXADOR
- 25 CABO DE AÇO COM PONTEIRAS
- 26 SUPORTE DO BALANCIN (orelha)



 <p>Trilho Curvado D - 99.00.439 E - 99.00.375</p>	 <p>Pega Mão de Plas. ou Aço P - 99.00.260 A - 99.00.741</p>	 <p>Cantoneira do Trilho 99.00.419</p>	 <p>Puxador 99.00.597</p>
 <p>Trilho Reto C/ Cantoneira D - 99.00.268 E - 74.00.167</p>	 <p>Trava Trinco 99.00.324</p>	 <p>Trinco da Porta Roll - UP 99.00.320</p>	 <p>Óculos Inferior 99.00.624</p>
 <p>Suporte Regulavel 99.00.280</p>	 <p>Vedação Superior 15.00.005</p>	 <p>Perfil de Vedação Lateral 99.00.454</p>	 <p>C.j Dobradiça Lateral 99.10.014</p>
 <p>Dobradiça Intermediaria 99.00.643</p>	 <p>Suporte do Cabo de Aço 99.00.464</p>	 <p>Vedação Inferior 99.00.218</p>	 <p>Borracha Inferior aranha 15.00.002</p>



Borracha Lat. Porta roll-up
15.00.007



Rodizio
10.01.020



Varão do Balancin
99.00.445



Mola do Balancin
D - 99.00.166
E - 99.00.167



Carretel da Mola
D - 99.00.226
E - 99.00.228



Balancin da Porta Roll-UP
99.00.543



Suporte do balancin (orelha)
99.00.432



Suporte central do balancin
99.00.721



Castanha da Mola
D - 99.00.265
E - 99.00.266



Cabo de Aço
99.00.304



Suporte Inferior
99.00.657

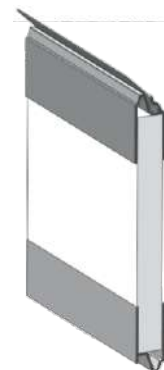

Painel Sup. Dobre Eixo
19.00.001



Painel Interme. Dobre Eixo
19.00.002

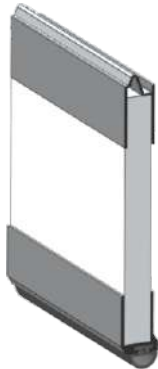

Painel Inferior. Dobre Eixo
19.00.003

Aceitamos todos os cartões



Aceitamos cartão





D.E.P.R.[®]

DOBRE EIXO PORTAS ROLL-UP

Lealdade em Negócios

PORTA ROLL-UP

Porta de Madeira Revestida com Alumínio



Porta de madeira
Revestida com alumínio



WWW.DOBREEIXO.COM.BR

Essa Sua Frota Merece

Porta de madeira Revestida com alumínio

Porta Roll-up

Peças de Reposição



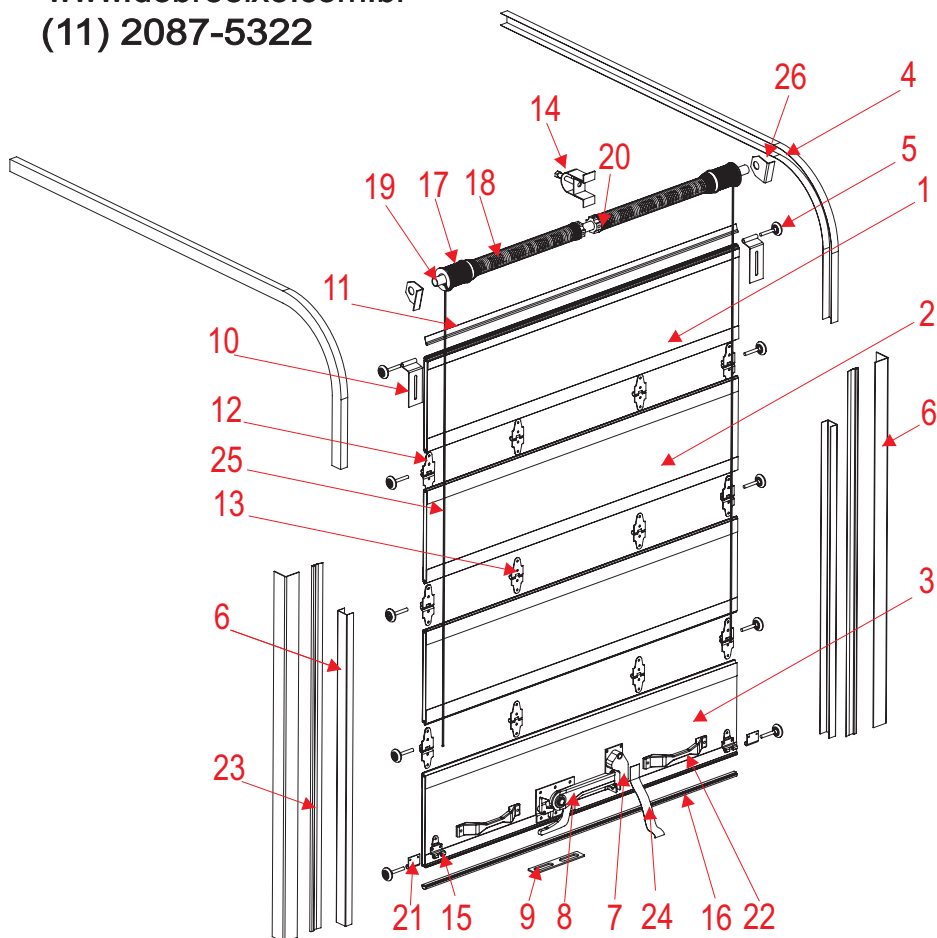





www.dobreeixo.com.br
(11) 2087-5322

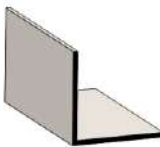



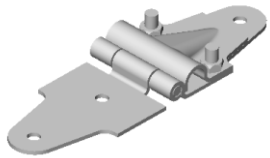











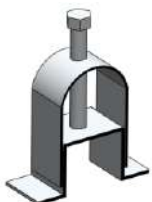

Descrição

- | | |
|----|------------------------------|
| 1 | PAINEL SUPERIOR |
| 2 | PAINEL INTERMEDIARIO 400 MM |
| 3 | PAINEL INFERIOR |
| 4 | TRILHO CURVADO |
| 5 | RODIZIO |
| 6 | C.J CANTONEIRA E TRILHO RETO |
| 7 | C.J. TRAVA TRINCO |
| 8 | TRINCO DA PORTA |
| 9 | OCULOS |
| 10 | SUPORTE REGULAVÉL |
| 11 | VEDAÇÃO SUPERIOR |
| 12 | C.J DA DOBRADIÇA LATERAL |
| 13 | DOBRADIÇA INTERMEDIARIA |
| 14 | SUPORTE CENTRAL DO BALANCIN |
| 15 | SUPORTE DO CABO DE AÇO |
| 16 | VEDAÇÃO INFERIOR |
| 17 | CARRETEL DO CABO DE AÇO |
| 18 | MOLA |
| 19 | VARÃO DA MOLA |
| 20 | CASTANHA DA MOLA |
| 21 | SUPORTE INFERIOR |
| 22 | PEGA MÃO |
| 23 | VEDAÇÃO LATERAL |
| 24 | PUXADOR |
| 25 | CABO DE AÇO COM PONTEIRAS |
| 26 | SUPORTE DO BALANCIN (orelha) |



 <p>Trilho Curvado D - 99.00.439 E - 99.00.375</p>	 <p>Pega Mão de Plas. ou Aço P - 99.00.260 A - 99.00.741</p>	 <p>Cantoneira do Trilho 99.00.419</p>	 <p>Puxador 99.00.597</p>
 <p>Trilho Reto C/ Cantoneira D - 99.00.268 E - 74.00.167</p>	 <p>Trava Trinco 99.00.324</p>	 <p>Trinco da Porta Roll - UP 99.00.320</p>	 <p>Óculos Inferior 99.00.624</p>
 <p>Suporte Regulavel 99.00.280</p>	 <p>Vedação Superior 15.00.005</p>	 <p>Perfil de Vedação Lateral 99.00.454</p>	 <p>C.j Dobradiça Lateral 99.10.014</p>
 <p>Dobradiça Intermediaria 99.00.643</p>	 <p>Suporte do Cabo de Aço 99.00.464</p>	 <p>Vedação Inferior 99.00.218</p>	 <p>Borracha Inferior aranha 15.00.002</p>

 <p>Borracha Lat. Porta roll-up 15.00.007</p>	 <p>Castanha da Mola D - 99.00.265 E - 99.00.266</p>	 <p>Varão do Balancin 99.00.445</p>	 <p>Mola do Balancin D - 99.00.166 E - 99.00.167</p>
 <p>Carretel da Mola D - 99.00.226 E - 99.00.228</p>	 <p>Balancin da Porta Roll-UP 99.00.543</p>	 <p>Suporte do balancin (orelha) 99.00.432</p>	 <p>Suporte central do balancin 99.00.721</p>
 <p>Cabo de Aço 99.00.304</p>	 <p>Suporte Inferior 99.00.657</p>	 <p>Rodizio 10.01.020</p>	 <p>Painel Sup. de Madeira Revestido de Alumínio 19.00.004</p>
 <p>Painel Interm. de Madeira Revestido de Alumínio 19.00.005</p>	 <p>Painel Inferior de Madeira Revestido de Alumínio 19.00.006</p>	<p>Aceitamos todos os cartões</p>  	<p>Aceitamos cartão</p> 



Painel Intem. de Madeira
99.00.082 - 295 mm
99.00.616 - 395 mm



Painel Inter. Revest. de Alum.
99.00.713 - 395 mm
99.00.714 - 295 mm



Painel Inter. Reve. de Alum.
99.00.514

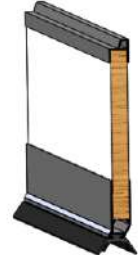

Painel Inferior
99.00.510

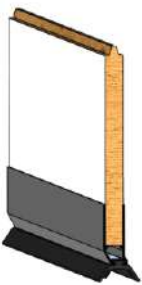

Painel Inf.c/ perfil e borracha
295 mm - 99.00.602
395 mm - 99.00.903



Painel Superior
99.00.490

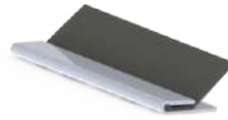

Cj de Vedação Lat.
99.00.454



Suporte do balancin (orelha)
99.00.432



Balancin da Porta Roll-UP
99.00.543



Suporte Inferior do Rodizio
99.00.642



Suporte central do balancin
99.00.721



Borracha Inferior
99.00.720

Aceitamos cartão



Aceitamos todos os cartões





D.E.P.R.[®]

DOBRE EIXO PORTAS ROLL-UP

Lealdade em Negócios

PORTA ROLL-UP

REFRIGERADA

O painel de nossa porta refrigerada possui placa de poliuretano de 50 mm de espessura revestida com chapa lisa de alumínio branca.



Lançamento

WWW.DOBREEIXO.COM.BR

Essa Sua Frota Merece

Porta Refrigerada

Porta Roll-up

Peças de Reposição

www.dobreeixo.com.br
(11) 2087-5322

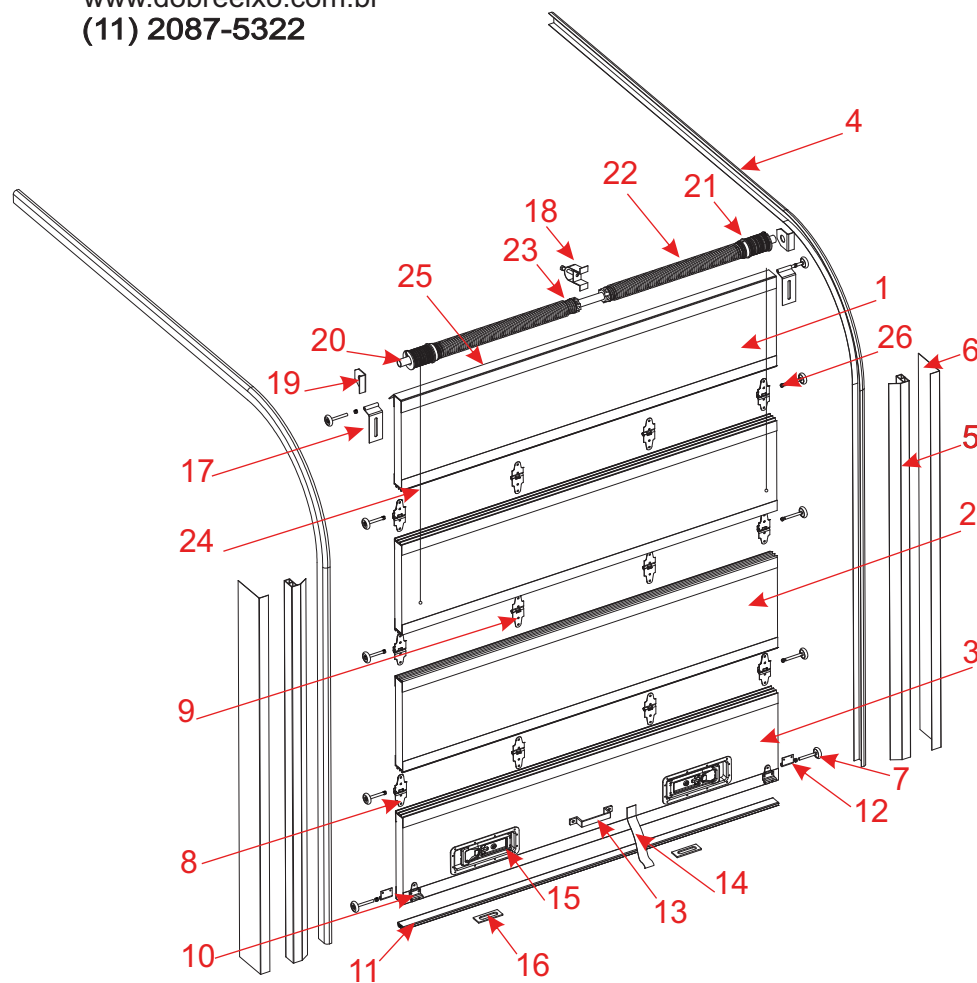

Descrição

- 1 - PAINEL SUPERIOR
- 2 - PAINEL INTERMEDIÁRIO
- 3 - PAINEL INFERIOR
- 4 - TRILHO CURVADO
- 5 - VEDAÇÃO
- 6 - C.j CANTONEIRA E TRILHO
- 7 - RODIZIO
- 8 - C.j DOBRADIÇA LATERAL
- 9 - DOBRADIÇA INTERMEDIÁRIA
- 10 - SUPORTE DO CABO DE AÇO
- 11 - VEDAÇÃO INFERIOR
- 12 - SUPORTE INFERIOR
- 13 - PEGA MÃO INOX
- 14 - PUXADOR
- 15 - BANDEJA INOX COM CHAVE
- 16 - ÓCULOS
- 17 - SUPORTE REGULÁVEL
- 18 - SUPORTE CENTRAL DO BALANCIN
- 19 - SUPORTE DO BALANCIN (ORELHA)
- 20 - VARÃO DO BALANCIN
- 21 - CARRETEL DA MOLLA
- 22 - MOLLA DIREITA E ESQUERDA
- 23 - CASTANHA DA MOLLA
- 24 - CABO DE AÇO
- 25 - VEDAÇÃO SUPERIOR
- 26 - MOLLA DO RODIZIO

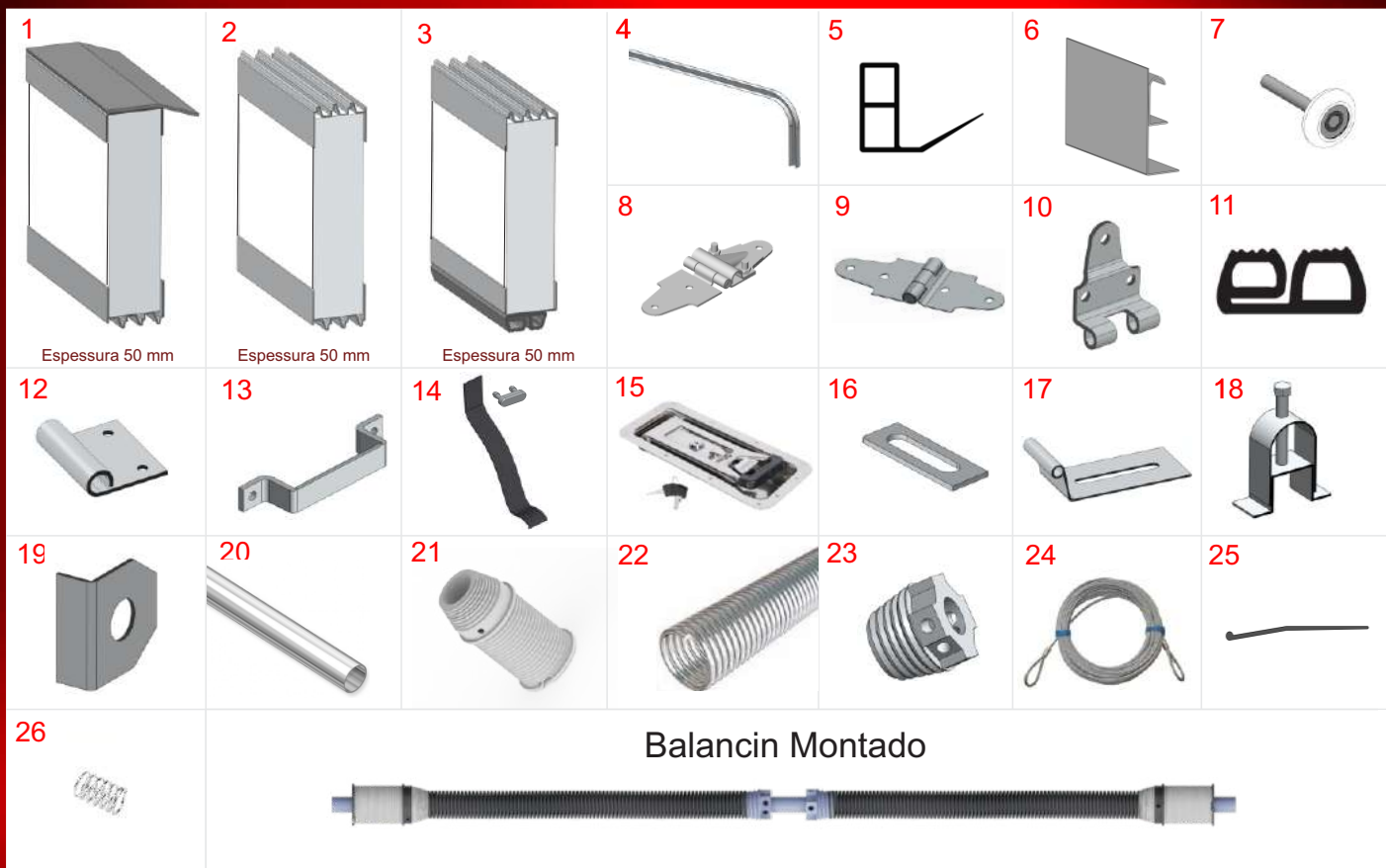

 <p>Trilho Curvado D - 99.00.439 E - 99.00.375</p>	 <p>Pega Mão Inox 99.00.838</p>	 <p>Rodizio 10.01.020</p>	 <p>Puxador 99.00.597</p>
 <p>Cj Cantoneira e Trilho D - 16.00.010 E - 74.00.167</p>	 <p>Bandeja Inox 99.00.406</p>	 <p>Bando 99.00.064</p>	 <p>Óculos Inferior 16.00.009</p>
 <p>Suporte Regulavel Inox 16.00.011</p>	 <p>Vedação Lateral 99.00.904</p>	 <p>C.j. Dobradiça Lat. Inox 16.00.007</p>	 <p>Dobradiça interme. Inox 16.00.008</p>
 <p>Vedação Inferior 99.00.347</p>	 <p>Sup. do Cabo de Aço Inox 16.00.012</p>	 <p>Cabo de Aço 99.00.304</p>	 <p>Suporte Inferior inox 16.00.013</p>



Castanha da Mola
D - 16.00.014
E - 16.00.015



Carretel da Mola
D - 99.00.226
E - 99.00.228



Varão do Balancin
16.00.022



Mola do Balancin
D - 16.00.019
E - 16.00.017



Suporte do balancin (orelha)
16.00.020



Suporte central do balancin
16.00.021



Balancin da Porta Roll-UP
16.00.023



Painel Superior
19.00.007

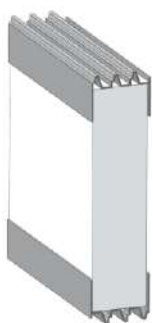

Painel Intermediario
19.00.008

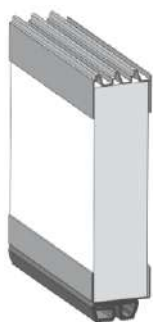

Painel Inferior
19.00.009

Aceitamos todos os cartões



Aceitamos cartão



Aceitamos todos os cartões



Aceitamos cartão



Aceitamos todos os cartões



Aceitamos cartão





DOBRE EIXO[®]
PEÇAS PARA BAÚS E SIDER

Lealdade em Negócios

PORTA ROLL-UP PARA DOCAS

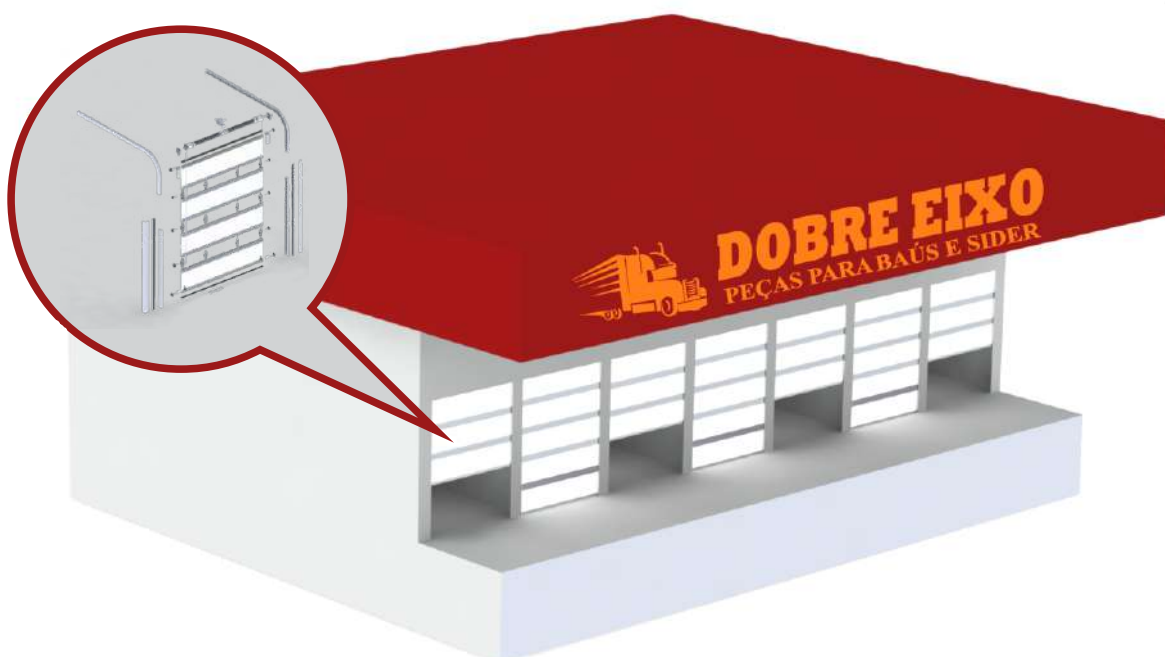

WWW.DOBREEIXO.COM.BR



PORTA DE MADEIRA REVESTIDA COM ALUMINIO



PORTA 100% ALUMINIO



PORTA REFRIGERADA



CORTE E DOBRA



PERFILADEIRA



CORTE A PLASMA



CENTRO DE USINAGEM



**GRUPO
DOBRE EIXO**
PEÇAS PARA BAÚS E SIDER

Lealdade em Negócios

+5511 2087-5322

BAÚ PARTS

PEÇAS PARA BAÚS E SIDER

(19) 3864-0522



**ATENDEMOS EM TODO BRASIL
E AMÉRICA LATINA**

Vendedor: _____

Email: _____

@dobreeixo.com.br